

 **Beta**



Speciale

Utensili Moto

2018



www.beta-tools.it





Beta Utensili è azienda leader nella produzione di utensili manuali professionali.

La qualità e l'affidabilità dei prodotti Beta sono garantite da oltre ottant'anni di esperienza e tradizione.

Prodotti continuamente aggiornati la cui qualità è altamente apprezzata dai tecnici delle migliori squadre corse nel Motomondiale, Mondiale Superbike, Mondiale Motocross ed Enduro.

Un impegno costante nella ricerca dell'eccellenza, che ha coinvolto tutti i processi aziendali e permesso di ottenere già nel 1995 la certificazione Sistemi di Qualità ISO 9001.

2018

Lo "Speciale Utensili Moto" è una selezione accurata di prodotti specifici dedicati al settore dei motocicli. Manutenzione generale, serraggio controllato, cavalletti e sollevatori oltre ad un serie di articoli specifici per il settore sono presentati dando ampio spazio ai contenuti tecnici.

Un utile estratto da una gamma di prodotti che supera le 10.000 referenze, un indispensabile strumento per identificare il prodotto più adatto a soddisfare le necessità dei professionisti più esigenti.

50
years in Motorsports



Indice



2÷11

**Contenitori
e assortimenti**



34-35

Impianto elettrico

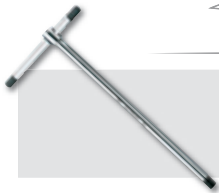

12÷27

Utensili generici



36-37

**Trasmissione - Freni
- Sospensioni**



16-17

**Serraggio
controllato**



38÷41

Ruote



28-29

Diagnostica



42÷47

**Cavalletti e
sollevatori**



30÷32

Motore



48-49

**Attrezzatura
specifica**



32-33

Olio e filtri

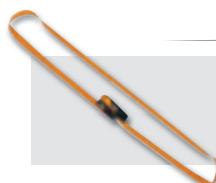

50÷52

**Sistemi di
ancoraggio**

Cassettiera portatile



C22S

Cassettiera portatile con tre cassetti

- Tre cassetti da 588x277 mm, montati su guide telescopiche a sfera:
 - 1 cassetto altezza 50 mm
 - 2 cassetti altezza 70 mm.
- Serratura centralizzata frontale.
- Maniglie laterali a scomparsa per il trasporto.



C22S-O	19 kg	022000501
C22S-G	19 kg	022000502
C22S-R	19 kg	022000503

h	max
50 mm	25 kg
70 mm	25 kg

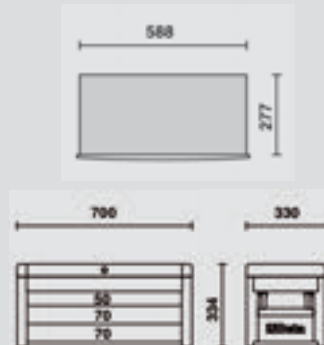

C23S

Cassettiera portatile con cinque cassetti

- Cinque cassetti da 588x277 mm, montati su guide telescopiche a sfera:
 - 2 cassetti altezza 50 mm
 - 3 cassetti altezza 70 mm.
- Serratura centralizzata frontale.
- Maniglie laterali a scomparsa per il trasporto.



C23S-O	26 kg	023000501
C23S-G	26 kg	023000502
C23S-R	26 kg	023000503

h	max
50 mm	25 kg
70 mm	25 kg

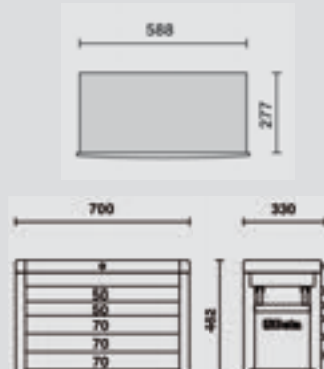

C23SC

Cassettiera portatile con otto cassetti

- Otto cassetti montati su guide telescopiche a sfera:
 - 4 cassetti altezza 50 mm
 - 3 cassetti altezza 70 mm
 - 1 cassetto altezza 100 mm.
- Serratura centralizzata frontale.
- Maniglie laterali a scomparsa per il trasporto.



C23SC-O	28 kg	023000511
C23SC-G	28 kg	023000512
C23SC-R	28 kg	023000513

h	max
50 mm	25 kg
70 mm	25 kg



Cassettiera mobile



C24S/5

Cassettiera mobile con cinque cassetti

- Cinque cassetti da 588x367 mm, montati su guide telescopiche a sfera:
 - 2 cassetti altezza 70 mm
 - 2 cassetti altezza 140 mm
 - 1 cassetto altezza 280 mm
- Piano dei cassetti protetto da tappetini di gomma espansa.
- Quattro ruote Ø 125 mm:
 - 2 fisse e 2 girevoli (una con freno).
- Serratura di sicurezza centralizzata frontale.
- Capacità di carico statico: 800 kg.
- Piano di lavoro termoplastico sul quale è collocabile a misura una cassetteria C22S, C23S, C23SC e C23ST
- Portaflacone laterale integrato.
- Possibilità di applicazione del portacarta 2400S-R/PC.



C24S/5-O	52 kg	024002051
C24S/5-G	52 kg	024002052
C24S/5-R	52 kg	024002053

h	max
70 mm	25 kg
140 mm	30 kg
280 mm	35 kg

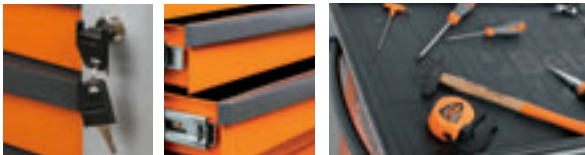
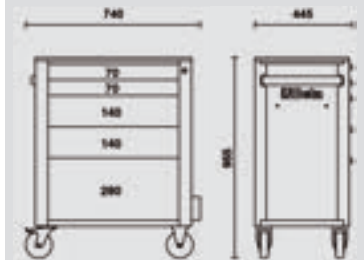

C24S/7

Cassettiera mobile con sette cassetti

- Sette cassetti da 588x367 mm, montati su guide telescopiche a sfera:
 - 5 cassetti altezza 70 mm
 - 1 cassetto altezza 140 mm
 - 1 cassetto altezza 210 mm
- Piano dei cassetti protetto da tappetini di gomma espansa.
- Quattro ruote Ø 125 mm:
 - 2 fisse e 2 girevoli (una con freno).
- Serratura di sicurezza centralizzata frontale.
- Capacità di carico statico: 800 kg.
- Piano di lavoro termoplastico sul quale è collocabile a misura una cassetteria C22S, C23S, C23SC e C23ST
- Portaflacone laterale integrato.
- Possibilità di applicazione del portacarta 2400S-R/PC.



C24S/7-O	58 kg	024002071
C24S/7-G	58 kg	024002072
C24S/7-R	58 kg	024002073

h	max
70 mm	25 kg
140 mm	30 kg
210 mm	30 kg

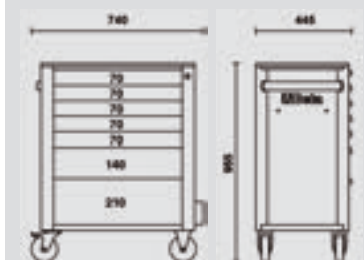
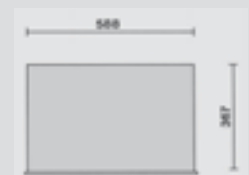

Contenitori e assortimenti



C33/7

Cassettiera mobile con sette cassette

- Sette cassette da 588x367 mm, montati su guide telescopiche a sfera:
 - 5 cassette altezza 75 mm
 - 1 cassette altezza 150 mm
 - 1 cassetto altezza 225 mm
- Piano di lavoro multifunzione ad alta resistenza.
- Portaminuterie e fori per l'alloggiamento dei giravite.
- Pratica scanalatura a "V" per la lavorazione di tubi o profilati.
- Sistema a sgancio rapido in nylon rinforzato fibra di vetro con possibilità di apertura su tutta la lunghezza del cassetto.
- Paracolpi angolari su tutta l'altezza della cassettiera per evitare, in caso di urto, il danneggiamento dei veicoli all'interno dell'officina.
- Piano dei cassette protetto da tappetini di gomma espansa.
- Quattro ruote Ø 125 mm:
 - 2 fisse e 2 girevoli (una con freno).
- Serratura di sicurezza centralizzata frontale.
- Capacità di carico statico: 1000 kg.
- Portaflaconi e portacarta laterali integrati regolabili in più posizioni.



C33/7-O	71 kg	033000271
C33/7-G	71 kg	033000272
C33/7-R	71 kg	033000273

h	max
75 mm	30 kg
150 mm	35 kg
225 mm	35 kg

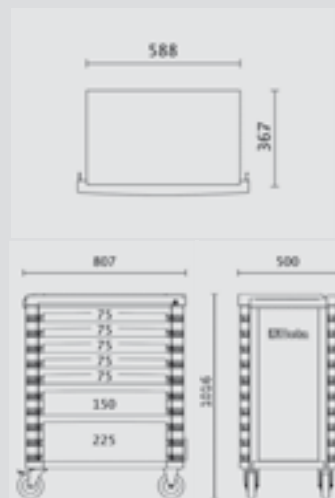

C33N
limited edition



C27S

Carrello portautensili richiudibile per interventi esterni, vuoto

- Struttura in lamiera.
- Carrello richiudibile con colonnine ribaltabili per permettere un agevole trasporto.
- Modello registrato.
- 2 cassette 588x277 mm montati su guide telescopiche che permettono l'apertura in due sensi.
- Ampio vano portaoggetti inferiore 588x277x220 mm.
- 2 ruote fisse Ø 160 mm e 2 ruote piroettanti con freno Ø 100 mm
- Piano di lavoro termoplastico con 6 vaschette portaminuterie integrate.
- Chiusura centralizzata.
- Predisposizione per l'alloggiamento di separatori per cassetto e termoformati portautensili MC10, MC20



C27S-O	20 kg	027000201
C27S-G	20 kg	027000202
C27S-R	20 kg	027000203

h	max
70 mm	20 kg



Trolley portautensili



C41S

Trolley portautensili a due moduli sovrapponibili

- Struttura in lamiera e piani in materiale plastico: grande robustezza e peso ridotto.
- 2 moduli separabili:
 - 1 cestello superiore,
 - 1 modulo con 1 cassetto altezza 95 mm e 1 cassetto altezza 295 mm.
- Ruote di grosso diametro (160 mm), integrate nella struttura per facilitare il trasporto anche su gradini.
- Serratura centralizzata laterale per la chiusura dei 2 cassetti del modulo inferiore.
- Cassetti montati su guide telescopiche a sfera con doppio gancio di chiusura.
- Impugnatura con manico telescopico in alluminio.
- Portaminuterie integrato nel cestello superiore.
- Cassetto inferiore con doppia guida telescopica



C41S 16 kg 041000001

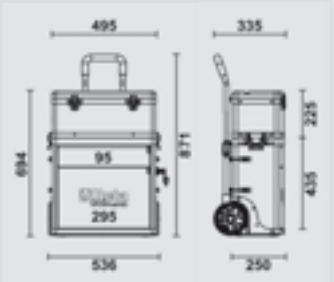

C41H

Trolley portautensili a due moduli sovrapponibili

- Struttura in lamiera e piani in materiale plastico: grande robustezza e peso ridotto.
- 2 moduli separabili:
 - 1 cestello superiore,
 - 1 modulo con 2 cassetti altezza 95 mm, 1 cassetta estraibile in materiale plastico altezza 66 mm e 1 cassetto altezza 295 mm.
- Ruote di grosso diametro (160 mm), integrate nella struttura per facilitare il trasporto anche su gradini.
- Serratura centralizzata laterale per la chiusura dei cassetti del modulo inferiore.
- Cassetti montati su guide telescopiche a sfera con doppio gancio di chiusura.
- Impugnatura con manico telescopico in alluminio.
- Portaminuterie integrato
- Cassetto inferiore con doppia guida telescopica



C41H 21 kg 041000002

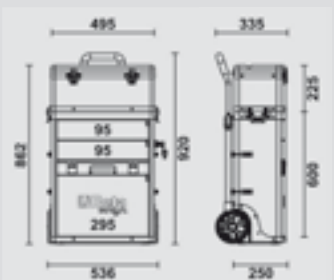
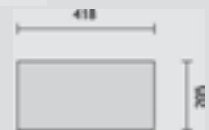

* Colorazioni disponibili su richiesta

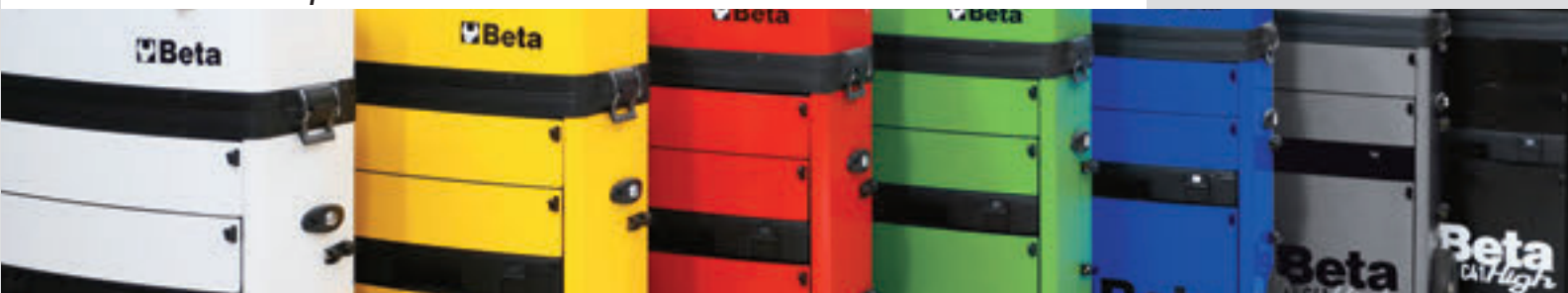

Contenitori e assortimenti



C51

Carrello

- 3 ripiani ricoperti in gomma millerighe antiscivolo
- Maniglia ergonomica
- Doppia possibilità di fissaggio del ripiano centrale
- Quattro ruote Ø 100 mm: 2 fisse e 2 girevoli (una con freno).
- Capacità di carico statico: 200 kg. (distribuita sui 3 ripiani)



	Icona	Peso	Articolo
C51-O		21 kg	051000001
C51-G		21 kg	051000002
C51-R		21 kg	051000003

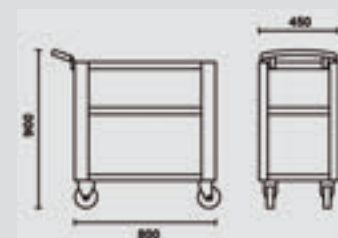

C56

Banco da lavoro

- Piano di lavoro in lamiera verniciata con bordo perimetrale
- Struttura in acciaio con 6 gambe di sostegno
- Capacità di carico statico: 1.200 kg
- Abbinabile alla parete C57P non fissabile al piano di lavoro.
- Due cassette dotate di serratura.
- Predisposizione per il fissaggio al pavimento.

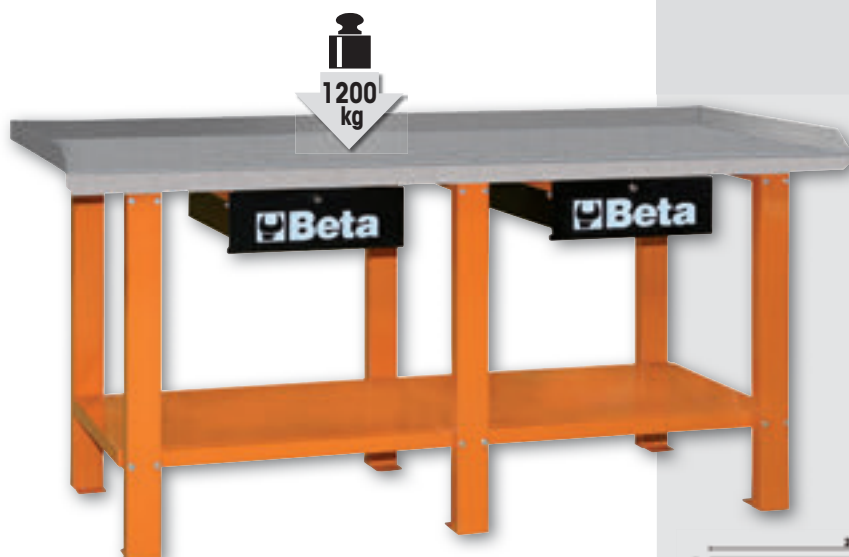

	Icona	Peso	Articolo
C56-O		82 kg	056000201
C56-G		82 kg	056000202
C56-R		82 kg	056000203



Cassettiera mobile RACING

- Piano di lavoro in legno multistrato
- Serratura di sicurezza centralizzata frontale
 - 4 ruote Ø 125 mm
- 2 fisse e 2 girevoli (una con freno) con copertura a vista
- Capacità di carico statico: 1200 Kg



C39SM

Cassettiera speciale mobile tipo Racing SM

- Modulo con 7 cassetti da 588x367 mm, montati su guide telescopiche a sfera: 6 cassetti altezza 70 mm 1 cassetto altezza 240 mm
- Piano dei cassetti protetto da tappetini di gomma espansa.
 - Sistema di apertura posizionato su tutta la lunghezza del cassetto.
 - Frontalino del cassetto in alluminio.

Modulo di servizio

- Cestino portarifiuti integrato
- Vano portacarta per rotoli integrato
- 1 cassetto portaoggetti 380x305x270 mm



C39SM-O	125 kg	039390001
C39SM-G	125 kg	039390002
C39SM-R	125 kg	039390003

h	max
70 mm	30 kg
240 mm	40 kg



C39MD

Cassettiera speciale mobile tipo Racing MD

- Modulo con 7 cassetti da 588x367 mm, montati su guide telescopiche a sfera: 6 cassetti altezza 70 mm 1 cassetto altezza 240 mm
- Piano dei cassetti protetto da tappetini di gomma espansa.
 - Sistema di apertura posizionato su tutta la lunghezza del cassetto.
 - Frontalino del cassetto in alluminio.

Modulo con 2 cassetti

- da 588x367x270 mm e 588x367x380 mm, montati su guide telescopiche a sfera
- Piano dei cassetti protetto da tappetini di gomma espansa
 - Sistema di apertura posizionato su tutta la lunghezza dei cassettoni
 - Frontalino dei cassettoni in alluminio.



C39MD-O	123 kg	039390101
C39MD-G	123 kg	039390102
C39MD-R	123 kg	039390103

h	max
70 mm	30 kg
240 mm	40 kg

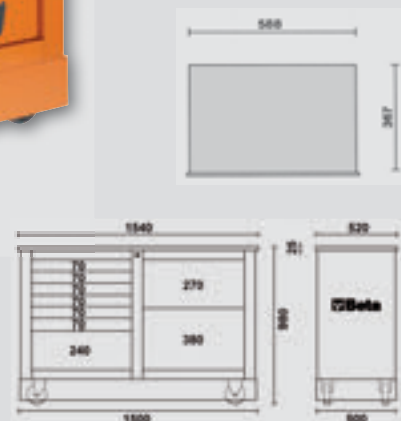

Contenitori e assortimenti



5904VG/2M

Assortimento di 170 utensili in termoformato morbido



M15 M16 VP/M3



M50 M55 M86



M208 M85 M234



M83 M131 M145

Per cassettiere C24S e C33



N. pezzi/Descrizione

N. pezzi/Descrizione	Beta N.	TR
16 chiavi combinate 6÷21 mm	42	M15
5 chiavi combinate 22 - 24 - 27 - 30 - 32 mm	42	M16
8 chiavi maschio esagonale con impugnatura \odot 2-2,5-3-4-5-6-7-8 mm	96T	M50
6 chiavi maschio con impugnatura per viti con impronta Torx® \odot T10-T15-T20-T25-T27-T30	97TTX	M55
7 inserti maschio esagonale \odot 4-5-6-7-8-10-12 mm	867PE	M86
7 inserti maschio esagonale \odot 4-5-6-7-8-10-12 mm	867PE/L	M86
5 inserti a profilo XZN® \odot 5-6-8-10-12 mm	867XZN	M86
5 inserti a profilo XZN® \odot 5-6-8-10-12 mm	867XZN/L	M86
7 inserti per viti con impronta Torx® \odot T20-T25-T30-T40-T45-T50-T55	867TX	M86
6 inserti per viti con impronta Torx® \odot T25-T30-T40-T45-T50-T55	867TX/L	M86
7 inserti per viti con impronta Tamper Resistant Torx® \odot T20-T25-T30-T40-T45-T50-T55	867RTX	M86
1 bussole portainseriti per 867	867/1	M86
1 bussole portainseriti per 867	867/2	M86
5 giravite lama piatta \bullet 3x75 - 4x100 - 4x125 - 5,5x150 - 6,5x150 mm	1260	M208
3 giravite per viti con impronta a croce Phillips® \oplus PH0x60 - PH1x80 - PH2x100 mm	1262	M208
1 giravite nano lama piatta \bullet 4x30 mm	1260N	M208
1 giravite nano Phillips® \oplus PH1x30 mm	1262N	M208
5 inserti colorati per avvitatori per viti a testa con intaglio \bullet 0,5x3 - 0,6x4,5 - 0,8x5,5 - 1x5,5 - 1,2x6,5 mm	860LP	M85
8 inserti colorati maschio esagonale per avvitatori \odot 2 - 2,5 - 3 - 4 - 5 - 6 - 8 - 10 mm	860PE	M85
5 inserti colorati per avvitatori per viti con impronta a croce Phillips® \oplus PH0 - PH1 - PH2 - PH3 - PH4	860PH	M85

N. pezzi/Descrizione

N. pezzi/Descrizione	Beta N.	TR
4 inserti colorati per avvitatori per viti con impronta a croce Pozidriv® - Supadriv® \oplus PZ1 - PZ2 - PZ3 - PZ4	860PZ	M85
10 inserti colorati per avvitatori per viti con impronta Torx® \odot T7-T8-T9-T10-T15-T20-T25-T27-T30-T40	860TX	M85
8 inserti colorati per avvitatori per viti con impronta Tamper Resistant Torx® \odot T9-T10-T15-T20-T25-T27-T30-T40	860RTX	M85
1 portainseriti a sgancio rapido con impugnatura 230 mm	851SR	M85
1 cricchetto reversibile portainseriti 100 mm	860/55	M85
2 scalpelli piatti nervati 100 - 200 mm	35	M234
1 martello tipo tedesco 300 g	1370	M234
1 mazzuola con battenti in materiale plastico \varnothing 35 mm	1390	M234
1 prolunga angolare - 1/2" 125 mm	920AN/125	M83
1 prolunga angolare - 1/2" 250 mm	920AN/250	M83
1 snodo 1/2"	920/25	M83
1 quadro maschio 1/2" con spina scorrevole	920/42	M83
1 cricchetto reversibile 1/2" \oplus	920/55	M83
19 chiavi a bussola esagonali 1/2" \odot 10÷24 - 26 - 27 - 30 - 32 mm	920A	M83
1 pinza universale 180 mm	1150BM	M131
1 pinza a becchi mezzotondi dritti \bullet 160 mm	1166BM	M131
1 tronchesi a grande effetto taglienti diagonali ∇ 160 mm	1084BM	M131
1 pinze becchi dritti per anelli elastici, per fori \odot 180 mm	1032	M145
1 pinze becchi piegati per anelli elastici, per fori \odot 170 mm	1034	M145
1 pinze becchi dritti per anelli elastici, per alberi \bullet 175 mm	1036	M145
1 pinze becchi piegati per anelli elastici, per alberi \bullet 175 mm	1038	M145
1 termoformato morbido con 3 vaschette portaminuterie	VPM3	

5904VG/2M 17 kg 059040198



5940SBK

Assortimento di 125 utensili



N. pezzi/Descrizione

- 1 punzoni Ø 2 mm
- 1 bulino Ø 4 mm
- 1 scalpelli piatti 125 mm
- 10 chiavi combinate 6 - 7 - 8 - 10 - 11 - 12 - 13 - 14 - 17 - 19 mm
- 6 chiavi a forchetta 6x7 - 8x9 - 10x11 - 12x13 - 14x15 - 16x17 mm
- 9 chiavi maschio esagonale piegate \odot 1,5 - 2 - 2,5 - 3 - 4 - 5 - 6 - 8 - 10 mm
- 1 chiave dinamometrica a scatto 3/8", 8+60 Nm
- 54 assortimento di 52 inserti con attacco esagonale 10 mm e 2 accessori
- 17 assortimento di 12 chiavi a bussola e 5 accessori
- 1 raccordo quadro maschio 1/2" e femmina 3/8"
- 2 chiavi a bussola per candele 3/8" \odot 16 - 17,8 mm
- 1 pinza a becchi mezzotondi lunghissimi \bullet 283 mm
- 2 pinze becchi dritti per anelli elastici, per fori \odot 140 - 180 mm
- 1 pinze becchi dritti per anelli elastici, per alberi \bullet 140x1,3 mm
- 1 tronchesi a taglienti diagonali ∇ 160 mm
- 1 forbici per elettricisti lame dritte
- 1 pinza universale \equiv 180 mm
- 1 giravite Dzus® \bullet
- 4 giravite lama piatta \bullet 3x75 - 4x100 - 5,5x100 - 6,5x150 mm
- 3 giravite Phillips® \oplus PH0x60 - PH1x80 - PH2x100 mm
- 1 giravite provacircuito \bullet
- 1 martello tipo tedesco 300 g
- 1 chiave regolabile a nastro per filtri olio
- 1 spessimetro
- 1 miniseghetto
- 1 spazzola fili d'ottone
- 1 oliatore in plastica a pressione 250 cc

Beta N.

- 30
- 32
- 34
- 42
- 55
- 96/SC9
- 606/6
- 867/C52
- 920A/C12X
- 910/16
- 956E
- 1009L/A
- 1032
- 1036
- 1082
- 1128BM
- 1150
- 1201DZ
- 1201
- 1202
- 1254
- 1370
- 1491
- 1708/13
- 1725CR
- 1737
- 1754

Per cassettiere C41S e C41H



5940SBK 13 kg 059400081

34 MC10



42 6-7-8-9-10-11-12-13-14-15-16-17-18-19-21-22 mm
 96/SC9 1,5-2-2,5-3-4-5-6-8-10 mm
 1084BM 160 mm
 1150BM 180 mm
 1166BM 160 mm
 1201 3,5x100-5,5x150-6,5x150 mm
 1202 PH0x60-PH1x80-PH2x100 mm

3,5 kg 027500010

74 MC20



860MIX/A31	900BG/30C
895/1	900/42
1048 250 mm	900/55
1370 300 g	920A 10-11-12-13-14-15-16-17-18-19-21-22-24-27-30-32 mm
32 Ø 4 mm	920/25
36 Ø 4 mm	920AN/125 125 mm
900 4-4,5-5-5,5-6-7-8-9-10-11-12-13-14 mm	920/42
900/21 150 mm	920/55
900/25	

6 kg 027500020

16 M15



42 6-7-8-9-10-11-12-13-14-15-16-17-18-19-20-21 mm

1,5 kg 024500015

17 M33



55 6x7-8x9-10x11-12x13-14x15-16x17-18x19-20x22 mm
 ○96/SC9 1,5÷10 mm

1,1 kg 024500033

12 M46



142SN 8-9-10-11-12-13-14-15-16-17-18-19 mm

1,4 kg 024500046

8 M50



○96T 2-2,5-3-4-5-6-7-8 mm

1,1 kg 024500050

5 M55



○97TTX T10-T15-T20-T25-T30

330 g 024500055

16 M65

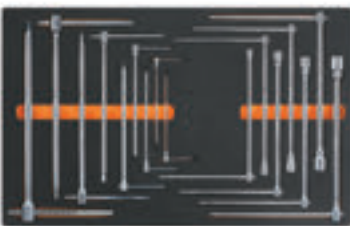

950 8-10-12-13-14-17-19 mm
 951 2,5-3-4-5-6-8-10-12-14 mm

3,6 kg 024500065

9 M69



○951 2,5-3-4-5-6-8-10-12-14 mm

1,8 kg 024500069

24 M83



12"
 ○920A 10-11-12-13-14-15-16-17-18-19-20-21-22-23-24-26-27-30-32 mm
 920AN/125 125 mm
 920AN/250 250 mm
 920/25 255 mm
 920/42 305 mm
 ○920/55

3,7 kg 024500083

45 M85



1/4
 851SR 230 mm
 ○860LP 0,5x3 - 0,6x4,5 - 0,8x5,5 - 1x5,5 - 1,2x6,5 mm
 ○860PE 2 - 2,5 - 3 - 4 - 5 - 6 - 8 - 10 mm
 ○860PH PH0 - PH1 - PH2 - PH3 - PH4
 ○860PZ PZ1 - PZ2 - PZ3 - PZ4
 ○860TX T6-T7-T8-T9-T10-T15-T20-T25-T27-T30-T40
 ○860RTX T9-T10-T15-T20-T25-T27-T30-T40
 860/55 100 mm
 882P 80 mm

450 g 024500085

46 M86



10
 ○867PE 4-5-6-7-8-10-12 mm
 ○867PE/L 4-5-6-7-8-10-12 mm
 ○867XZN 5-6-8-10-12 mm
 ○867XZN/L 5-6-8-10-12 mm
 ○867TX T20-T25-T30-T40-T45-T50-T55
 ○867TX/L T25-T30-T40-T45-T50-T55
 ○867RTX T20-T25-T30-T40-T45-T50-T55

867/1
 867/2

1,4 kg 024500086

25 M91



14"
 ○900 4-4,5-5-5,5-6-7-8-9-10-11-12-13-14 mm
 ○900ME 2,5-3-4-5-6-8 mm
 900/20 50 mm
 900/21 150 mm
 900/25 □ 1/4 - ■ 1/4
 900BG/30
 900/42
 ○900/55

560 g 024500091

22 M92



- 910A 6-7-8-9-10-11-12-13-14-15-16-17-18-19-20-21-22 mm
- 910/21 125 mm
- 910/22 250 mm
- 910/25
- 910/42
- ⊕ 910/55

1,5 kg 024500092

98 M100

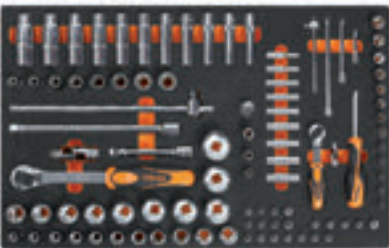

- 895/1
- 895/3
- 895/6
- 900 4-4,5-5-5,5-6-7-8-9-10-11-12-13-14 mm
- 900L 5-6-7-8-9-10-11-12-13 mm
- 900ME 3-4-5-6-7 mm
- 900LP 0,8x4-1x5,5-1,2x6,5-1,2x8 mm
- ⊕ 900PH PH1-PH2-PH3-PH4
- ⊕ 900TX T10-T15-T20-T25-T27-T30-T40
- 900/20 50 mm
- 900/20L 100 mm
- 900/21 150 mm
- 900/25
- 900BG/30
- 900/42
- ⊕ 900/55
- 920A 8-10-11-12-13-14-15-16-17-18-19-20-21-22-23-24-26-27-28-30-32 mm
- 920/15 920/25
- 920AN/125 125 mm
- 920AN/250 250 mm
- 920/42
- ⊕ 920/55
- 920FTX 10-12-14-16-18-20-22-24 mm
- 920AL 10-12-13-14-15-16-17-18-19-21-22 mm

6,7 kg 024500100

13 M130



- 1032 180 mm
- 1034 170 mm
- 1036 175 mm
- 1038 175 mm
- 1048 250 mm
- 1052 240 mm
- ⊔ 1082BM 160 mm
- 1098 220 mm
- 1112 250 mm
- 1128BM
- 1150BM 180 mm
- 1166BM 160 mm
- 1168BM 160 mm

3,4 kg 024500130

3 M131



- ⊔ 1084BM 160 mm
- 1150BM 180 mm
- 1166BM 160 mm

750 g 024500131

4 M145



- 1032 180 mm
- 1034 170 mm
- 1036 175 mm
- 1038 175 mm

640 g 024500145

2 M153



- 1048 250 mm
- 1052 240 mm

1 kg 024500153

6 M204



- ⊕ 1267TX T8-T10-T15-T20-T25-T30

450 g 024500204

10 M208



- 1260 3x75 - 3,5x100
4x125 - 5,5x150
6,5x150 mm
- ⊕ 1262 PH0x60
PH1x80
PH2x100 mm
- 1260N 4x30 mm
- ⊕ 1262N PH1x30 mm

750 g 024500208

25 M210



- 1201 2,5x50-3x75-4x100-5,5x125-6,5x150-8x200 mm
- 1201N 4x30 mm
- ⊕ 1202 PH0x60-PH1x80-PH2x100-PH3x150 mm
- ⊕ 1202N PH1x30 mm
- ⊕ 1207TX T6-T7-T8-T9-T10-T15-T20-T25-T27-T30-T40-T45
- 1253

1,8 kg 024500210

25 M230



- 30 Ø 2-3-4 mm
- 31 Ø 2-3-4-5-6-8 mm
- 32 Ø 4 mm
- 34 150 mm
- 35 200-250 mm
- 36 125 mm
- 1370 500 g
- 1390 Ø 35 mm
- 1692 3 m
- 1712TF
- 1771 18 mm
- 1719BMA/Q 200 mm
- ▲ 1719BMA/T 200 mm
- 1719BMA/P 200 mm
- ▶ 1719BMA/M 200 mm
- 1719BMA/R 200 mm
- 1737NX
- 1771 18 mm

3,2 kg 024500230

4 M234



- 35 100-200 mm
- 1370 300 g
- 1390 Ø 35 mm

1,3 kg 024500234



1281BG/B28A

1/4"

Assortimento di
16 giravite bivalenti,
9 chiavi a bussola 1/4",
2 accessori e 1 impugnatura
di manovra, in busta



	900	4 - 4,5 - 5 - 5,5 6 - 7 - 8 - 9 - 10 mm
	1281BG	
	1281PB	1/4
	900/25	
	1281LP/1	0,8x4 - 1,2x6,5 mm
	1281LP/2	1,0x5,5 - 1,2x6,5 mm
	1281PH/1	PH1 - PH2
	1281PH/2	PH2 - PH3
	1281PZ/1	PZ1 - PZ2
	1281PZ/2	PZ2 - PZ3
	1281PE	2,5 - 3 - 4 - 5 - 6 mm
	1281TX/1	T6 - T8
	1281TX/2	T7 - T9
	1281RTX/3	T10 - T15
	1281RTX/4	T20 - T25
	1281RTX/5	T30 - T40

1281BG/B28A 1,1 kg 012810510



1281BG-TX/A8

1/4"

Assortimento di
8 giravite bivalenti
e 1 impugnatura di manovra,
in astuccio



	1281BG	
	1281LPH/1	PH0-0,8x4 mm
	1281LPH/2	PH1-1x5,5 mm
	1281LPH/3	PH2-1,2x6,5 mm
	1281TX/1	T6-T8
	1281TX/2	T7-T9
	1281TX/3	T10-T15
	1281TX/4	T20-T25
	1281TX/5	T30-T40

1281BG-TX/A8 527 g 012810530



1281BG/A9

1/4"

Assortimento di
9 giravite bivalenti
e 1 impugnatura di manovra,
in astuccio



	1281BG	
	1281LPH/1	PH0-0,8x4 mm
	1281LPH/2	PH1-1x5,5 mm
	1281LPH/3	PH2-1,2x6,5 mm
	1281PZ/1	PZ1-PZ2
	1281PE	2,5 mm
	1281PE	3 mm
	1281PE	4 mm
	1281PE	5 mm
	1281PE	6 mm

1281BG/A9 567 g 012810520

Chiavi



950

Chiavi a T semplici esagonali cromate

- Asta di manovra scorrevole arrestabile nella posizione desiderata su tutta la lunghezza.
- Un fermo di sicurezza impedisce la fuoriuscita dell'asta per evitare incidenti.
- Tripla marcatura della misura sulla testa.

UNI 6742 DIN 3112

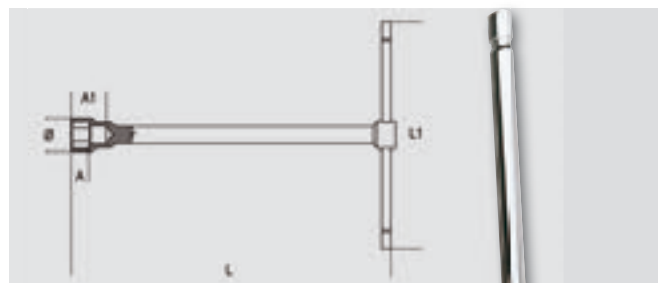

mm	L mm	Ø mm	L1 mm	A mm	A1 mm	g	Icon	mm	L mm	Ø mm	L1 mm	A mm	A1 mm	g	Icon
6	210	10,1	145	5,0	16,0	98	Icon	14	250	20,1	190	11,5	25,0	289	Icon
7	212	11,2	145	6,0	18,0	100	Icon	15	254	21,5	190	12,0	25,0	307	Icon
8	220	12,4	160	7,0	19,0	140	Icon	16	260	22,7	200	12,5	26,0	414	Icon
9	223	13,5	160	8,0	20,0	142	Icon	17	264	24,1	200	13,0	27,0	436	Icon
10	230	14,9	160	8,5	21,0	172	Icon	19	274	26,6	230	14,5	29,0	553	Icon
11	233	16,1	160	9,0	22,0	176	Icon	22	290	29,9	290	16,0	32,0	797	Icon
12	240	17,5	175	9,5	23,0	228	Icon	24	300	32,2	320	18,0	36,0	976	Icon
13	244	19,7	175	10,5	24,0	233	Icon	27	315	36,2	370	21,0	42,0	1265	Icon

Serie di chiavi a T semplici esagonali

950/S9

7-8-10-11-12-13-14-17-19 mm

2,3 kg 009500079

950/14

6-7-8-9-10-11-12-13-14-15-16-17-19-22 mm

4,1 kg 009500082



951

Chiavi a T con tre estremità maschio esagonale cromate

- Concepita per sviluppare coppie elevate.
- Estremità esagonali calibrate, per un perfetto accoppiamento con la vite.
- L'astina esagonale può essere arrestata nella posizione desiderata su tutta la lunghezza; un fermo di sicurezza ne impedisce l'estrazione.

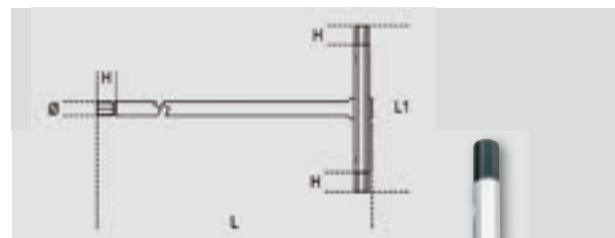

mm	L mm	L1 mm	Ø mm	H mm	g	Icon	mm	L mm	L1 mm	Ø mm	H mm	g	Icon
2	125	63	4,0	5,5	20	Icon	6	215	99	8,0	10	117	Icon
2,5	150	63	4,0	6	20	Icon	7	230	109	9,0	11	163	Icon
3	150	63	4,0	6,5	22	Icon	8	250	122	10,0	12	219	Icon
3,5	175	76	5,5	7,5	46	Icon	9	265	132	11,0	13	289	Icon
4	175	76	5,5	8	47	Icon	10	280	142	12,0	14	371	Icon
4,5	195	87	6,5	8,5	75	Icon	12	305	160	15,0	15	613	Icon
5	195	87	6,5	9	76	Icon	14	330	178	17,0	17	884	Icon

Utensili generici

Serie di chiavi a T con tre estremità maschio esagonale

951/S8

2-2,5-3-3,5-4-4,5-5-6 mm

400 g 009510693

951/S14

2-2,5-3-3,5-4-4,5-5-6-7-8-9-10-12-14 mm

3,1 kg 009510695

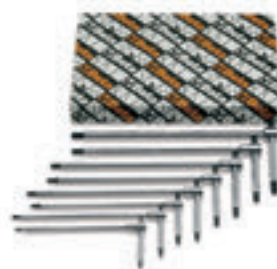

951TX

Chiavi a T con tre estremità maschio per viti con impronta Torx® cromate

- Concepita per sviluppare coppie elevate.
- Estremità calibrate, per un perfetto accoppiamento con la vite.
- L'astina esagonale può essere arrestata nella posizione desiderata su tutta la lunghezza; un fermo di sicurezza ne impedisce l'estrazione

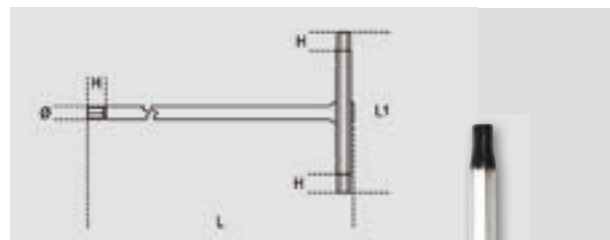

Ø	L mm	L1 mm	Ø mm	H mm	g	
T6	125	63	4	3,5	20	009510806
T7	125	63	4	3,5	20	009510807
T8	125	63	4	3,5	20	009510808
T9	125	63	4	3,5	20	009510809
T10	150	63	4	4	23	009510810
T15	150	63	4	4,2	22	009510815
T20	175	76	5	4,5	46	009510820

Ø	L mm	L1 mm	Ø mm	H mm	g	
T25	175	76	5	5	47	009510825
T27	195	87	6	5,5	74	009510827
T30	195	87	6	6,3	75	009510830
T40	215	99	7	6,5	115	009510840
T45	230	109	8	7,5	159	009510845
T50	250	122	9	9	215	009510850

Serie di chiavi maschio a T per viti con impronta Torx®

951TX/S6

T8-T10-T15-T20-T25-T30

0,5 kg 009510866

951TX/S13

T6-T7-T8-T9-T10-T15-T20-T25-T27-T30-T40-T45-T50

1 kg 009510863

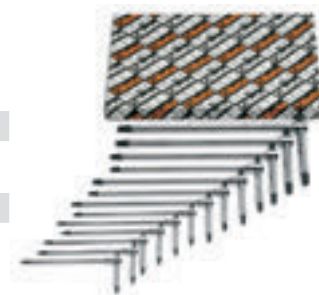

Bussole e accessori



860/C27

Assortimento di 25 inserti per avvitatori, 1 raccordo e 1 cricchetto reversibile in astuccio tascabile



	860/55	100 mm
	860/LP	0,5x3-1,0x5,5-1,2x6,5 mm
	860/PH	PH1-PH2(x2)-PH3
	860/PZ	PZ1-PZ2(x2)-PZ3
	860/PE	2-2,5-3-4-5-6 mm
	860/TX	T6-T8-T10-T15-T20-T25-T30-T40
	892/0	● 1/4 ■ 1/4

150x95x50 mm

860/C27

785 g 008600880



900/C39

Assortimento di 11 chiavi a bussola esagonali, 21 inserti per avvitatori e 7 accessori, in cassetta di plastica



1/4" 1/4"

	861LP	0,6x4,5-1,2x6,5-1,2x8 mm
	861PH	PH1-PH2-PH3
	861PZ	PZ1-PZ2-PZ3
	861PE	2,5-3-4-5-6 mm
	861RTX	T10-T15-T20-T25-T27-T30-T40
	900	5-5,5-6-7-8-9-10-11-12-13-14 mm
	900/20	50 mm
	900/20L	100 mm
	900/25	
	900BG/30C	
	900/55	
	892/0	
	895/1	

150x95x50 mm 900/C39 785 g 009000937



900/C12MR

Assortimento di 12 chiavi a bussola esagonali, 20 inserti per avvitatori e 7 accessori in termoformato morbido, in cassetta di lamiera

- Cricchetto reversibile con impugnatura rotante



1/4" 1/4"

	861LP	0,5x3-0,8x5,5-1x5,5-1,2x6,5 mm
	861PE	3-4-5-6-8 mm
	861PH	PH0-PH1-PH2-PH3
	861TX	T8-T10-T15-T20-T25-T30-T40
	895/1	□1/4" - □1/4"
	900	4-5-5,5-6-7-8-9-10-11-12-13-14 mm
	900/20	50 mm
	900/21	150 mm
	900/25	
	900/42	
	900BG/30	
	900/58	

350x150x50 mm 900/C12MR 1,3 kg 009000962



910A/C16HR

Assortimento di 16 chiavi a bussola esagonali e 5 accessori in cassetta di lamiera

- Cricchetto reversibile con impugnatura rotante



3/8"

	910A	6-7-8-9-10-11-12-13-14-15-16-17-18-19-21-22 mm
	910/21	125 mm
	910/22	250 mm
	910/25	
	910/42	
	910/58	

335x145x60 mm 910A/C16HR 2,4 kg 009100935



920A/C17MR

Assortimento di 17 chiavi a bussola esagonali e 5 accessori in termoformato morbido, in cassetta di lamiera

- Cricchetto reversibile con impugnatura rotante



1/2"

	920A	10-11-12-13-14-15-16-17-18-19-20-21-22-24-27-30-32 mm
	920/21	125 mm
	920/22	255 mm
	920/25	
	920/42	
	920/58	

420x185x60 mm 920A/C17MR 5,1 kg 009200937

Utensili generici



941

Chiavi a pipa esagonali-poligonali con impugnatura di manovra

- Chiave a bussola esagonale profonda sul lato lungo



mm	L mm	L1 mm	A1 mm	A mm	S mm	A2 mm	A3 mm	Ø mm	g	
7x7	200	91	35	6,0	20,6	15,5	6,0	11,0	104	009410107
8x8	220	107	50	7,0	25,2	18,5	7,0	12,2	151	009410108
9x9	220	109	50	8,0	25,2	19,5	8,0	13,5	163	009410109
10x10	236	111	50	8,5	25,2	20,5	8,5	15,0	194	009410110
11x11	236	114	50	9,0	25,2	21,5	9,0	16,0	203	009410111
12x12	255	122	50	9,5	27,6	22,5	9,5	17,5	284	009410112
13x13	255	124	55	10,5	27,6	23,5	10,5	18,5	302	009410113

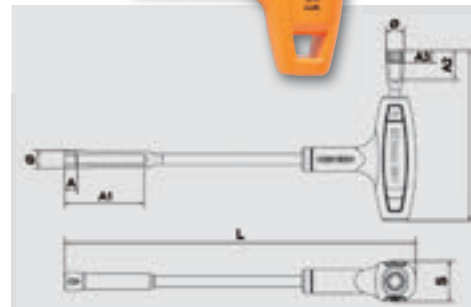

943FL

Chiavi a bussola esagonale flessibili con impugnatura bussola cromata



mm	L mm	L1 mm	Ø mm	A mm	A1 mm	g	
5	265	150	8	6,0	14,0	176	009430304
5,5	265	150	8	6,5	14,0	176	009430305
6	265	150	9	6,5	14,0	178	009430306
7	265	150	11	6,5	14,0	177	009430307
8	265	150	12	6,5	14,0	179	009430308
10	290	175	14	7,5	14,0	179	009430310

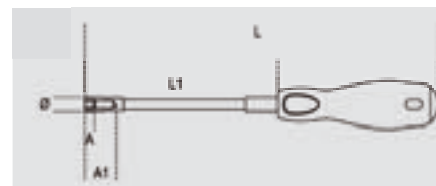

Serie di chiavi a bussola esagonale flessibili con impugnatura

943FL/S6

5-5,5-6-7-8-10 mm

1 kg 009430320



Serraggio controllato



600/1

Attrezzi per serraggi angolari



90 mm



600/1 1/2 1/2 548 g 006000001



601C

Goniometro digitale per serraggi angolari, magnetico

- Per effettuare serraggi di viti a tensioni prestabilite tramite la misurazione dell'angolo di torsione
- Dotato di avvisatore acustico (BUZZER) e avvisatori luminosi (LED) che segnalano l'avvicinamento e il raggiungimento dell'angolo impostato
- Per serraggi destrorsi e sinistrorsi
- Precisione angolo: +/-2%
- Risoluzione: 0,1°
- 9 valori di angolo preimpostabili
- 50 misurazioni preimpostabili
- Fornito in custodia ABS
- Alimentazione: 2 batterie AAA (incluse)



CE 601C 70 g 006010100

Chiavi dinamometriche a scatto con cricchetto reversibile precisione di serraggio ± 3%

- scala più grande del 60% per garantire una migliore visibilità e un settaggio più accurato
- velocità di regolazione della coppia aumentata del 40%
- materiale dell'impugnatura e lente resistenti a tutte le sostanze chimiche utilizzate nell'automotive, nell'industria e nell'aviazione
- la banda colorata (o-ring rosso posto all'estremità dell'impugnatura) indica che la chiave è sbloccata ed è possibile regolare la coppia di serraggio
- in fase di non utilizzo impostare la coppia sul valore più basso del range della chiave dinamometrica
- il Recalibration Reminder fornisce un'indicazione visiva del tempo mancante alla ricalibrazione della chiave (4 step: 3, 6, 9 e 12 mesi)



666N

PER SERRAGGI DESTROSI

UNI EN 26789 ISO 6789



	Nm	Kgfm	lbf.in	■	D mm	A mm	L mm	g	
666N/2	5÷25	0,5÷2,5	4÷18	1/4	25	29	215	300	006660002
666N/5	10÷50	1÷5	7÷37	3/8	30	33	312	660	006660005
666N/10	20÷100	2÷10	15÷75	3/8	30	33	381	730	006660010
666N/20	40÷200	4÷20	30÷150	1/2	40	43	470	1010	006660020
666N/30	60÷300	6÷30	50÷220	1/2	40	43	598	1380	006660030



667N/30

PER SERRAGGI DESTROSI E SINISTRORSI

UNI EN 26789 ISO 6789



	Nm	Kgfm	lbf.in	■	D mm	A mm	L mm	g	
667N/30	60÷300	6÷30	50÷220	1/2	40	43	598	1380	006670030



1430/S5

Serie di estrattori conici per viti e prigionieri danneggiati destrorsi in astuccio di plastica



1430/S5 M3+M18 133 g 014300105



1433/C11

Serie di 11 estrattori a rulli per viti prigioniere con attacco quadro femmina 1/2" ed esagono di manovra in cassetta metallica con termoformato morbido



3/8" 1/2"

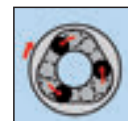
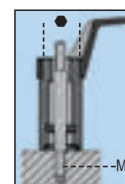

340x135x56 mm

1433/C11 M5 - M6 - M7 - M8 - M9 - M10 - M10,5
M11 - M12 - M14 - M16

M 19mm (M5)
21 mm (M6÷M12)
24 mm (M14-M16) 3,0 kg 014330311



1500N

Estrattori universali a 2 griffe scorrevoli

- Il particolare disegno della griffa permette un bloccaggio automatico della stessa sotto carico.
- Impiego sia per esterni che per interni.
- Griffe mobili lungo la traversa.

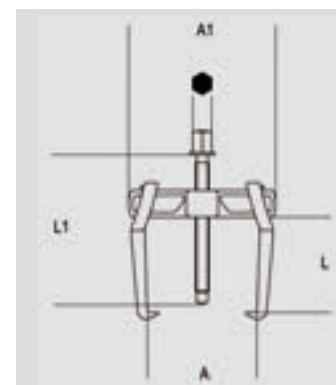

	A min÷Max mm	L mm	L1 mm	● mm	A1 mm	g	
1500N/0	18÷65	70	100	15	110	400	015000600
1500N/1	23÷70	100	130	17	130	700	015000601
1500N/2	23÷100	100	130	17	160	800	015000602
1500N/3	35÷140	150	190	20	230	2200	015000603
1500N/4	35÷190	150	190	20	280	2400	015000604
1500N/5	43÷250	205	295	27	360	5700	015000605
1500N/6	43÷320	205	295	27	430	6200	015000606



1535/C...

Estrattori combinati
in cassetta di lamiera

- Combinazione di tiranti 1533, prolunghe 1533PR e separatori 1534.
- Indicati dove gli estrattori a griffe danneggerebbero il pezzo.



	kg	015350001
1535/C1	2,5	015350001
☞ 260x180x40 mm		
	L mm	A min+max mm
1533/2	150	45+130
1533PR/1	100	
1534/1	88	5+60

	kg	015350002
1535/C2	2,8	015350002
☞ 260x180x40 mm		
	L mm	A min+max mm
1533/2	150	45+130
1533PR/1	100	
1534/2	118	12+75

	kg	015350003
1535/C3	8,0	015350003
☞ 380x280x55 mm		
	L mm	A min+max mm
1533/3	210	85+225
1533PR/2	100	
1534/3	118	22+115

	kg	015350004
1535/C4	14,8	015350004
☞ 420x380x65 mm		
	L mm	A min+max mm
1533/4	175	80+310
1533PR/3	100	
1534/4	205	25+155

	kg	015350005
1535/C5	27,4	015350005
☞ 530x510x85 mm		
	L mm	A min+max mm
1533/5	235	145+370
1533PR/3	100	
1534/5	290	30+220



1545/C5M

Estrattore 1542/1
con 5 espansori 1544
in cassetta di lamiera

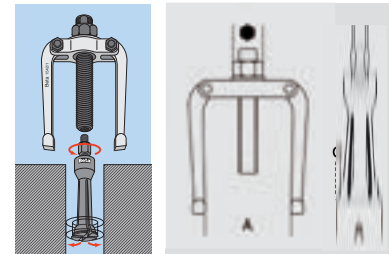

	A mm	C mm
1544/1	9+12	0,80
1544/2	13+17	1,15
1544/3	16+21	1,70
1544/4	20+25	1,65
1544/5	25+30	2,00

	A min+Max mm	● mm	kg	015450011
1542/1	35+75	24	2,4	015450011

☞ 265x180x45 mm

Manutenzione



31/B6

Serie di 6 cacciaspina
in busta

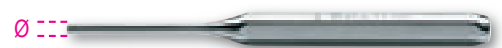

	Ø	kg	000310020
31/B6	2-3-4-5-6-8 mm	509 g	000310020

Utensili generici



99SQ

Chiavi a settore articolate con nasello quadro per ghiera cromate



	Ø mm	S mm	L mm	B mm	g	
99SQ 15-35	15-35	5,1	168	2,7	88	000990215
99SQ 35-50	35-50	6,0	208	3,5	156	000990235
99SQ 50-80	50-80	8,0	282	4,7	377	000990250
99SQ 80-120	80-120	8,3	344	6,2	667	000990280
99SQ 120-180	120-180	10,8	476	7,8	1400	000990290

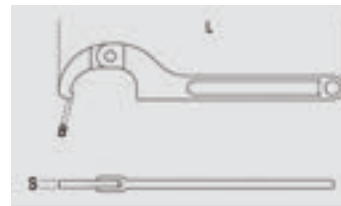

437U/09

Kit di ripristino delle filettature danneggiate

M5X0,8
M6X1,0
M8X1,25
M10X1,5
M12X1,75



370x230x55 mm



25x M5, M6, M8, M10
10x M12

		g	
437U/09	M5X0,8 - M6X1,0 M8X1,25 - M10X1,5 M12X1,75	2,7 kg	004370550



437C

Set ripristino filettature candela danneggiate M14x1,25 mm

• altezza elicotidi: 8,40 - 12,40 - 16,40 mm
(5 pz per misura)



M14 x 1,25 mm				

	g	
437C	1,1 kg	004370100



1254

Giravite provacircuito 6÷24V

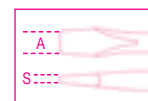

	SxAxL mm	L mm	g	
1254	0,5x3x44	123	30 g	012540001



1295/C14

Giravite a percussione
con 14 inserti
e bussola portainseri

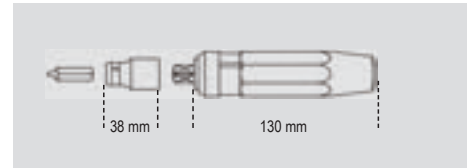

170x100x35 mm **1295/C14** 1,3 kg 012950108



1481PL/S3

Serie di 3 pinze in plastica
per occlusione tubi e manicoi



1481PL/A



1481PL/B



1481PL/C



1481PL/S3 **1481PL-A** Ø 8+15 mm 240 g 014810200
1481PL-B Ø 15+25 mm
1481PL-C Ø 25+45 mm



1599P

Morse parallele da banco
forgiate



	L1 mm	B mm	Ø mm	kg	
1599P 100	100	92	11	7.3	015990000
1599P 125	125	108	13	11.5	015990025
1599P 150	150	130	15	20.5	015990050



1599G

Coppie di copriganasce
in alluminio

- con fresatura interna per il bloccaggio di parti filettate



	A mm	kg	
1599G 100	100	183	015990910
1599G 125	125	222	015990912
1599G 150	150	260	015990915
1599G 180	180	302	015990917

Utensili generici



1712E/L1

*Flessibile magnetico
con illuminazione LED*



	L mm	D mm	F kg		
1712E/L1	500	11	0,75	500 g	017120111



1712E

Flessibili magnetici



	L mm	D mm	F kg		
1712E/1	420	7,5	0,5	145	017120011
1712E/2	530	15	1,8	232	017120012
1712E/3	532	19	3,0	239	017120013



1712TF

*Magnete telescopico
con testa flessibile*



	L mm	D mm	F kg		
1712TF	150+590	11	1	61 g	017120600



1737NX

*Spazzola curva
a fili di acciaio*

• impugnatura plastica



	L mm		
1737NX	270	144 g	017370010



1737

Spazzolino con fili di ottone



	L mm		
1737	145	20 g	017370001



1751

**Oliatori metallici
con cannuccia flessibile**

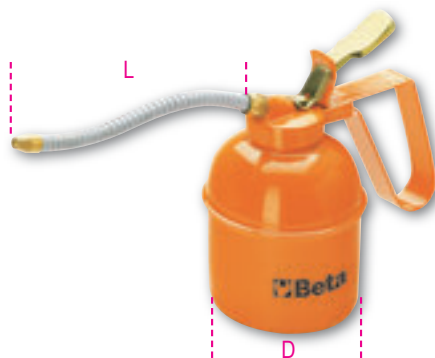

cc	D mm	L mm	g	
300	75	140	281	017510003
500	85	140	308	017510005



1753

**Oliatori in plastica
con cannuccia flessibile**



cc	D mm	L mm	g	
300	80	190	114	017530003
500	95	190	127	017530005



1756B

Siringa per olio

- Con zigrinatura antiscivolo

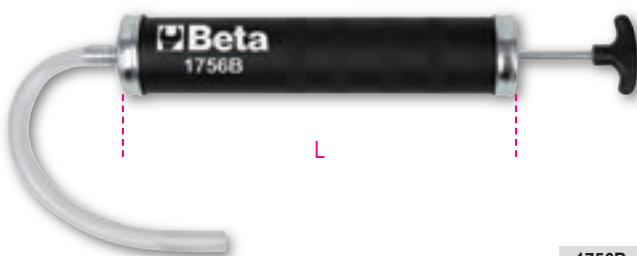

	cc	L mm	g	
1756B	500	190	820 g	017560220



1756C

**Siringa per olio da 200 ml
in polipropilene**

- Adatta anche a liquido impianto freni
- Doppia guarnizione in EPDM
- Temperatura di funzionamento: +0 - +50°C
- Non adatta per carburanti e oli minerali



	ml	L mm	g	
1756C	200	220	xx	017560502



1757

Rabboccatore per liquidi batterie



cc	D mm	g	
250	60	40 g	017570002

Utensili generici



1761

Pinza forcifilo a ritorno automatico

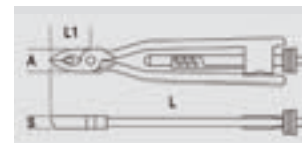

	L mm	L1 mm	A mm	S mm	📦	📦
1761	255	40	21	11	300 g	017610101



1761RS/1

Pinza forcifilo reversibile a ritorno automatico

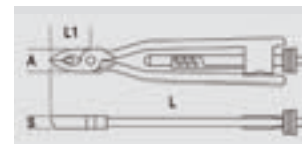

	L mm	L1 mm	A mm	S mm	📦	📦
1761RS/1	220	30	15	10	250 g	017610130



1767PMR

Portaminuterie magnetico rettangolare



1767PMR 017670010



1767PMC

Portaminuterie magnetico fondo



1767PMC 150 017670020



1835/1

Torcia LED per ispezioni, in robusto alluminio anodizzato

- Pile 1xAAA (non inclusa)
- IPX6



	L mm	📦	📦
1835/1	105	33 g	018350030



1835/2

Torcia LED per ispezioni, in robusto alluminio anodizzato

- Pile 2xAAA (non inclusa)
- IPX6



	L mm	📦	📦
1835/2	145	40 g	018350060



1838/11LED

**Lampada ricaricabile con LED
ad altissima luminosità
batteria ai polimeri di litio**

- Corpo compatto in gomma antiscivolo
- Con indicatore di batteria scarica
- Vetrino frontale facilmente sostituibile
- Gancio orientabile
- Con led in testa per illuminazione multidirezionale
- Con stazione di ricarica 100-230Vac / 50-60Hz
- 320 Lumen



IP65 CE 1838/11LED 334 g 018380111



1838COB

**Lampada ricaricabile compatta
con LED ad altissima luminosità.
Batteria ai polimeri di litio**

- Corpo compatto in gomma antiscivolo
- Gancio orientabile
- Base magnetica orientabile a 180 gradi
- Con caricatore 100-240Vac / 50-60Hz
- 55 / 110 lumen
- Autonomia: 5 / 2.5 ore
- IP20



CE 1838COB 200 g 018380010



1838SL

**Lampada ultrasottile con LED
ad altissima luminosità.
Per lavori in spazi ristretti**

- Alimentazione 12V con spina accendisigari e morsetti per batteria
- Cavo da 2,5 m
- Spessore 6mm
- 345 Lumen



CE 1838SL 6 mm 100 g 018380101

Utensili generici



1879

Aspiratore liquidi manuale e pneumatico da 9,5 Litri

Adatto per: olio motore, olio cambio, liquido freni, liquido raffreddamento, acqua, ecc...

- utilizzabile sia con pompa manuale sia con aria compressa
- pressione di esercizio: 3÷12 bar
- range di temperatura dei liquidi (1÷95 °C)
- fornito di 4 connessioni in nylon per i vari impieghi



1879 4,9 kg 018790001



1880

Pompa manuale per fusti olio

- Per olio
- Non usare con liquidi a base acquosa, solventi acidi, gasolio, benzina e simili
- Completa di attacco fusto, tubo telescopico e beccuccio di mandata



1880 240 gr 2,4 kg 018800001



1850B

Pistola termica 2 velocità

- Pos. I 240 l/min 300°C
- Pos. II 450 l/min 500°C



CE	L	H	W	°C	V	l/min	1 kg	018500011
	mm	mm	mm					
1850B	240	190	1600	300-500	230	240/450		



446/C30

Assortimento di maschi e filiere con accessori in acciaio al cromo filettatura metrica in cassetta di legno



430 M	440 M		
3x0,5	3x0,5	435/1,5	444/1
4x0,7	4x0,7		
5x0,8	5x0,8		
6x1	6x1		
8x1,25	8x1,25		
10x1,5	10x1,5		
12x1,75	12x1,75		

370x230x55 mm

446/C30



1,2 kg



004460055



1851VK

Pistola per colla a caldo con 12 stick di colla termofusibile in valigetta

- Ø 11 e 12 mm
- Potenza: 80 watt



320x250x50 mm



1851VK



600 g



018510058





960P

**Tester per controllo
pressione/depressione
con accessori e adattatori**



370x230x55 mm

960P

1,9 kg

009600777



1760PA/80

Pinza amperometrica AC/DC 80A
Specifica per misurazioni di bassi
valori di dispersione della corrente
o assorbimenti sui veicoli

- range: 1 mA-80A AC/DC
- funzione torcia con LED bianco
- display LCD retroilluminato
- funzione azzeramento
- funzione Hold
- autospegnimento
- alimentazione: 2 batterie 1,5V tipo AAA



CE

1760PA/80

270 g

017600002



1760B

Multimetro digitale

PARAMETRI RILEVABILI

Tensione DC: 200 mV-2/20/200/1000V

Tensione AC: 2-20/200/700V

Corrente DC: 2/20/200 mA-20 A

Corrente AC: 2/200 mA- 20 A

Resistenza: 200Ω - 2/20/200 kΩ - 2/20 MΩ

Capacità: 2/20/200 nF - 2/200 μF

Temperatura: -20° + 1000°C/ -4 °F ~ +2000°F

Frequenza: 20kHz

Alimentazione: 1 batteria da 9V (inclusa)

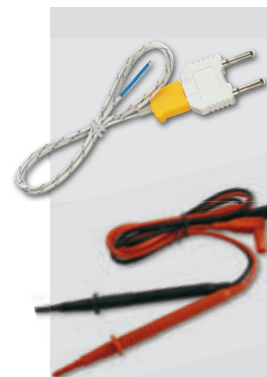

CE

1760B

670 g

017600012



1760/TC2

Tachimetro digitale a distanza e a contatto

DATI TECNICI

- Per misurazione di:
 - rotazione a distanza (g/min - rpm)
 - rotazione (g/min - rpm) e velocità lineare (m/min o ft/min) a contatto.
- Display LCD a 5 cifre.
- Scala:
 - a distanza 2,5÷99.999 g/min
 - a contatto 0,5÷19.999 g/min
 - velocità lineare 0,05÷1.999,9 m/min.
- Frequenza: 0,8 sec.
- Alimentazione: 4 batterie 1,5V (AA) (incluse) o alimentatore 6V (non incluso)



Fornito con:

- adattatore per misurazioni a contatto
- 2 puntali maschio in gomma
- 1 puntale femmina in gomma
- 1 rotella per rilevazioni lineari
- etichette riflettenti
- manuale di istruzioni
- custodia in plastica

	L mm	H mm		
CE 1760/TC2	230	74	570 g	017600161



1760/IR800

Termometro digitale ad infrarossi con doppio puntamento laser

DATI TECNICI

- Gamma: da -50°C a 800°C / da -58°F a 1472°F
 Selezione scala: °C/°F
 Precisione: ±1,0% o ±1,0°C a 20°C
 Potenza Laser: <1mW
 Risposta: 150ms
 Emissività: 0,10-1,0 regolabile
 Rapporto distanza: (D:S) 20:1
 Temperatura operativa:
 0°C ÷ 50°C / 32°F ÷ 122°F



- Umidità operativa: da 10% a 90% RH
 Display LCD retro-illuminato
 Funzione di mantenimento dei dati
 Auto spegnimento
 Alimentazione: 1 batteria 9V (inclusa)
 Custodia morbida in tela (inclusa)
 Manuale d'uso

	L mm	H mm		
CE 1760/IR800	95	145	350 g	017600380





955

Chiave a tubo semplice per candele d'accensione

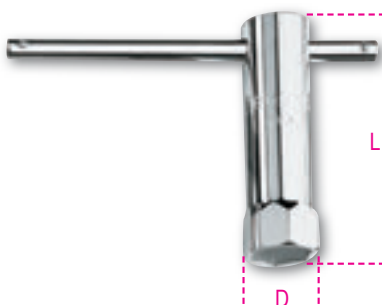

mm - "	D mm	L mm	g	
16 5/8	21	86	140	009550016
20,8 13/16	29	86	190	009550021



956C

Chiavi a bussola con attacco quadro femmina 1/2" per candele d'accensione

12" ISO 11168



mm - "	Ø mm	L mm	g	
14 9/16	18,8	70	95	009560008
16 5/8	21,4	70	105	009560010
17,8 11/16	23,6	70	140	009560011
20,8 13/16	27,0	70	160	009560012



956L

Chiavi a bussola poligonale con attacco quadro femmina 1/2" per candele d'accensione, tipo lungo

12" ISO 11168



mm - "	Ø mm	L mm	g		mm - "	Ø mm	L mm	g	
14 9/16	20,2	250	370	009560214	17,8 11/16	24,0	250	430	009560217
16 5/8	24,0	250	375	009560216	20,8 13/16	28,5	250	430	009560221



957

Chiavi a T con bussola snodata per candele d'accensione

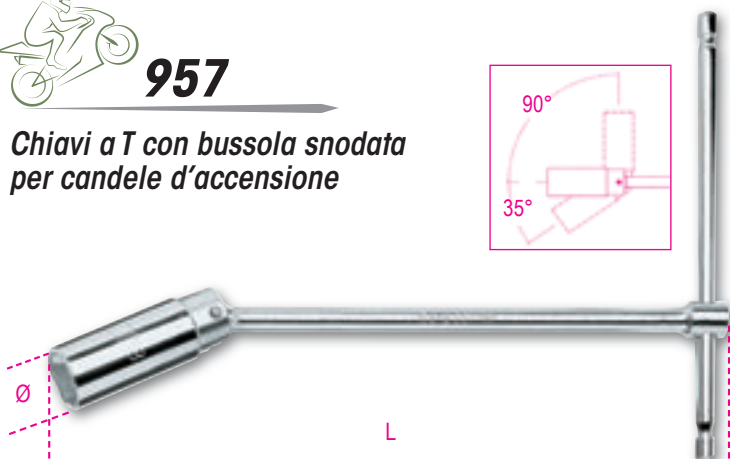
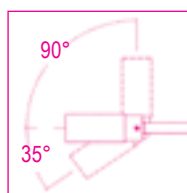

ISO 11168

mm - "	Ø mm	L mm	g	
16 5/8	21,4	275	300	009570000
20,8 13/16	27,0	275	340	009570001



1440

Attrezzi per inserimento pistoni



	Ø mm	D mm	g	
1440/0	40÷75	50	140	014400000
1440/1	57÷125	80	250	014400010
1440/1A	57÷125	100	300	014400011



1445/1

Attrezzi per segmenti di pistoni



	Ø mm		
1445/1	50÷100	200 g	014450001



1450GC

Morsetto alzavalvole con ganasce diritte e curve

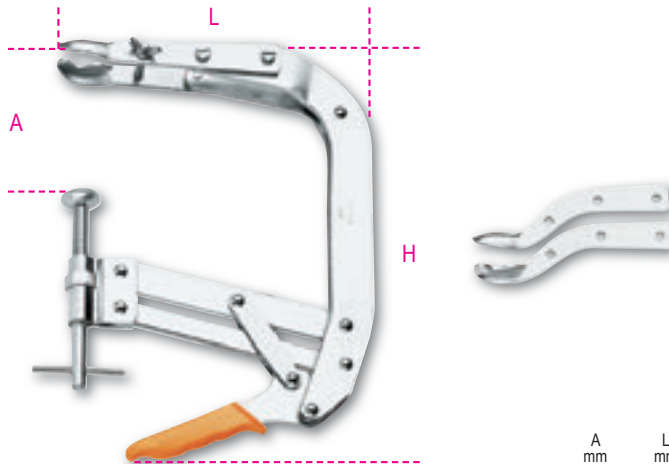

	A mm	L mm	H mm		
1450GC	45÷225	205	300	1,6 kg	014500005



1474L

Pinza per cappucci candele d'accensione a becchi lunghi piegati 15°

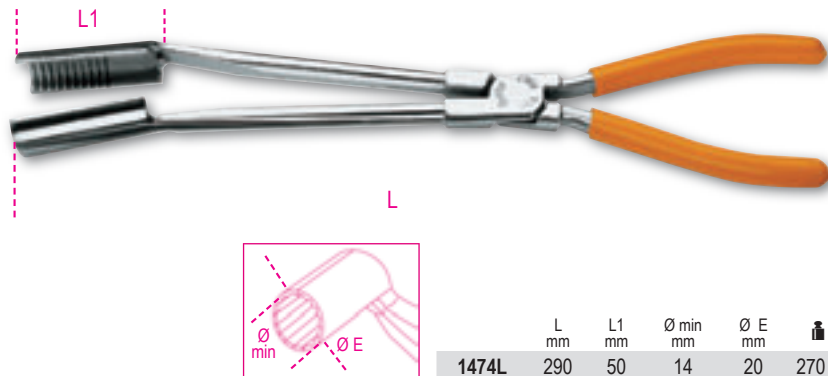

	L mm	L1 mm	Ø min mm	Ø E mm		
1474L	290	50	14	20	270 g	014740010



1474DL

Pinza per cappucci candele d'accensione a becchi lunghi manici ricoperti con 2 strati in PVC

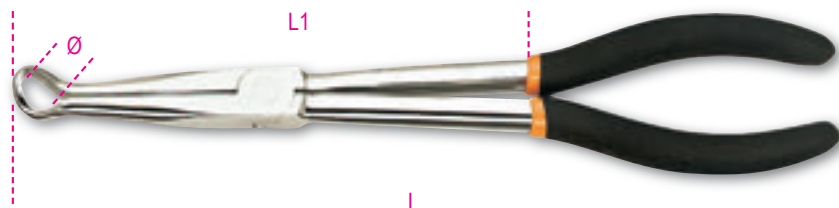

	L mm	L1 mm	Ø mm		
1474DL	275	170	12	310 g	014740015



1708/8

Spessimetri

- Lame in acciaio con estremità arrotondata
- Vite di bloccaggio
- Spessori in mm/pollici



	S mm	S "	L mm	Icona	Icona
1708/8	0,05±0,50	0,002±0,020	105	35 g	017080008



1439/K7

Cassetta giravite angolare 90° tipo lungo con lame

Dotazione valigetta:

- Giravite angolare
- 1 Testa per viti ad intaglio
- 1 Testa per bits 1/4
- 1 Testa per lame speciali
- 7 lame speciali

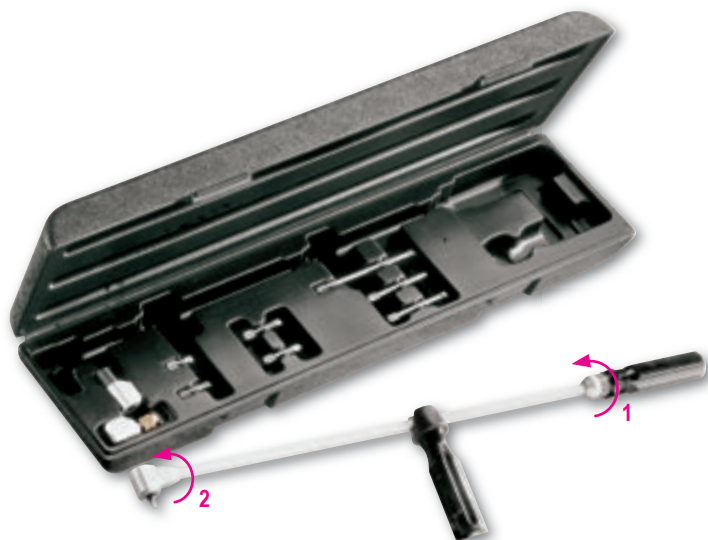

500x120x60 mm	1439/K7	1 kg	014390101
---------------	---------	------	-----------



1410/M

Attrezzo ad uncino per trazione molle



	L mm	∅ mm	Icona	Icona
1410/M	155	3,5	50 g	014100051



1490/1

Chiavi a nastro per filtri olio

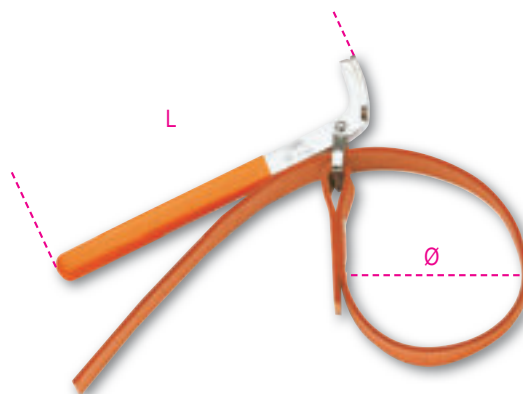

	∅ max mm	L mm	Icona	Icona
1490/1	160	225	290 g	014900001



1493T

Chiave autoregolabile a tre bracci per filtri olio sinistrorsa

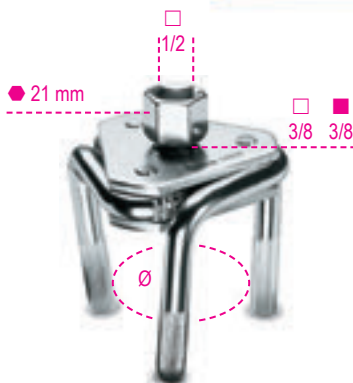

	Ø mm	g	
1493/T	60÷120	610	014930075



1493Z

Chiavi autoserranti per filtri olio sinistrorse

12"



	Ø mm	g	
1493Z/1	60÷80	410	014930090
1493Z/2	80÷100	710	014930095
1493Z/3	100÷125	1000	014930100



1493

Chiave a bussola per filtri olio

12"



	Ø mm	N	g	
1493 65-L14	65	14	120	014930200
1493 68-L14	68	14	140	014930206
1493 73-L14	73	14	151	014930208
1493 74-L14	74	14	142	014930209
1493 74-L15	74	15	151	014930210
1493 75/77-L15	75-77	15	161	014930212
1493 76-L8	76	8	147	014930214
1493 76-L14	76	14	170	014930218
1493 76-L15	76-74	15	183	014930220
1493 78-L15	78	15	161	014930224
1493 80-L15	80	15	163	014930226
1493 82-L15	82-80	15	192	014930228
1493 86-L16	86	16	234	014930230
1493 90-L15	90	15	204	014930234
1493 92-L10	92	10	192	014930236
1493 93-L15	93	15	209	014930238
1493 95-L15	95	15	198	014930244
1493 100-L15	100	15	253	014930248
1493 106-L15	106	15	245	014930250
1493 108-L15	108	15	247	014930252
1493 135-L18	135	18	571	014930256



1878 11

Vaschetta per recupero liquidi

- Capacità Massima 11 l
- Tappo scarico liquidi
- Paratia interna per evitare la fuoriuscita dei liquidi durante il trasporto



	g	
1878 11	850	018780011



1498/2A

Caricabatterie elettronico 12V per motocicli

Permette la carica di tutti i tipi di batterie al Pb Wet, Agm, Gel, Mf, Vrla e delle batterie al Litio LiFePo4

- Due specifici tipi di carica per batterie al Litio e al Piombo
- Ciclo di ricarica multifase automatico
- Protezione contro inversione di polarità e corto circuito
- Grado di protezione IP65
- Include cavo con pinze e cavo con occhielli
- Tensione di alimentazione: 220-240V



DATI TECNICI

- corrente di ricarica: 1A
- capacità di ricarica: 2Ah-40Ah
- frequenza: 50-60 Hz
- tensione della batteria: 12V
- dimensioni: 180x80x40 mm



1498/4A

Caricabatterie elettronico 6-12V auto-moto

- Protezione di inversione polarità, corto circuito
- Display digitale retroilluminato
- Gancio di fissaggio reclinabile
- Selezione automatica della tensione 6 o 12 Volt
- Selezione automatica del tipo di batteria
- Include cavo con pinze e cavo con occhielli



DATI TECNICI

- tensione di alimentazione: 220V-240V
- frequenza: 50-60 Hz
- corrente nominale (min-max): 1-4 Amp
- tensione della batteria: 6V/12V
- capacità batteria: 4Ah-80Ah
- tempo di ricarica: 12 ore
- grado di protezione: IP65





1498CM/12

Avviatore d'emergenza portatile per motocicli

3 funzioni in 1:

- avviatore
- batteria supplementare per apparecchi elettronici (tablet, smartphone, ecc...)
- torcia led ad alta luminosità

Dotazione:

- cavo di avviamento con pinze isolate e diodo di protezione
- caricabatteria da rete
- caricabatteria da auto
- cavo USB con adattatori di carica



DATI TECNICI

- corrente di avviamento: 200A
- corrente di picco: 400A
- uscita USB: 5V 2,1A
- dimensioni: 130x50x15 mm



1498CM/12 300 g 014980030





1568/C15

Kit per smagliatura e ribaditura catene

Ø 3-4-5 + kit Regina



420x185x60 mm 1568/C15 2 kg 015680015



3081

Smagliacatene portatile

Robusto e ripiegabile per facilitarne il trasporto nella borsa da enduro.

Adatto a catene 415, 420, 428, 520, 525, 530



3081 124 282 g 030810010



1467

Strumento estrazione liquido freni

Pressione min 5 bar, Max 11,5 bar



1467 1,5 1,5 kg 015680015



3085

Utensile per separazione pistoncini freno

Indicato per pinze freno moto e scooter

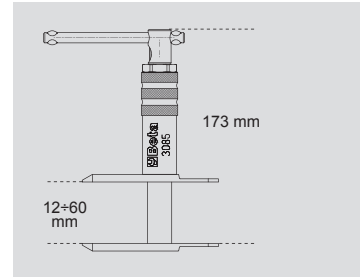

3085 694 g 030850010



3073

Inseritore universale paraoli forcella

Per diametri stelo da 43 a 48 mm

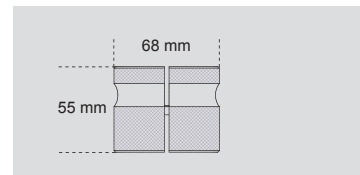

3073 221 g 030730001



3072

Smonta molle meccanico a vite per mono ammortizzatore e forcelle

Include kit adattatori per flange:
74-45-47-50-53-56-59-62-68-71-
75-77-80-84-87 mm

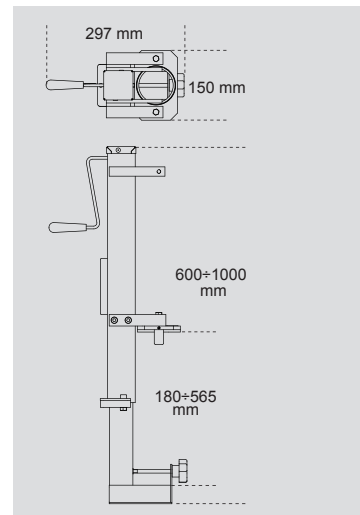

3072 18 kg 030720001



962

Levagomme



L mm	A mm	g		L mm	A mm	g	
300	21	300	009620003	500	27	750	009620005
400	25	450	009620004	600	27	1000	009620006



986 48

Giravite per valvole pneumatici modello corto

Ritenzione automatica della valvola
Particolarmente indicato per ruote di piccolo diametro tipo scooter

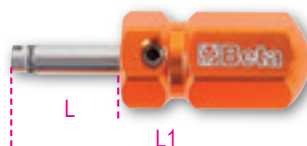

	L mm	L1 mm	g	
986 48	18	48	16 g	009860048



986 78

Giravite per valvole pneumatici

Ritenzione automatica della valvola



	L mm	L1 mm	g	
986 78	18	78	32 g	009860078



1949DGT

Pistola digitale per gonfiaggio pneumatici

- Pressione di esercizio: 0÷11 bar (2.0÷160 psi)
- 4 unità di misura: psi/bar/kgcm²/kpa
- Display LCD retroilluminato
- Funzione reset
- Autospegnimento dopo 3 min.
- Pulsante di scarico pressione
- Risoluzione: 0,05 bar
- Corpo in abs, guscio protettivo in gomma sul manometro, impugnatura antiurto e antiscivolo
- Alimentazione: 2 batterie 1,5V tipo AAA
- Compatibile con l'innesto 1916G 1/4"

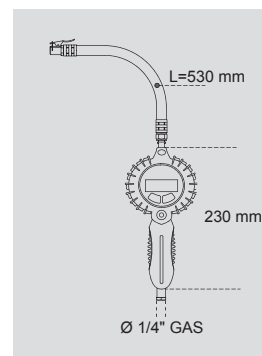

	bar	g	
CE 1949DGT	0÷11	500 g	019490020



1949GPE

Pistola per gonfiaggio pneumatici

- Pressione di esercizio: 0÷11 bar (10÷160 psi)
- Funzione di scarico pressione
- Funzione di solo misurazione della pressione
- Manometro rivestito in gomma antiurto
- Rotazione del tubo a 360°

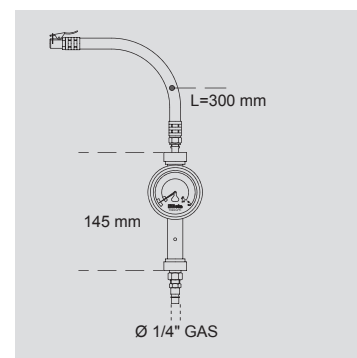

	bar		
1949GPE	0÷11	640 g	019490008



1949M

Misuratore di pressione per pneumatici

- Pressione di lettura: 0÷4 bar (5÷60 psi)
- Accuratezza: 0,1 bar (1,0 psi)
- Funzione di solo misurazione della pressione
- Funzione di scarico pressione
- Manometro rivestito in gomma antiurto
- Lunghezza del tubo: 350 mm

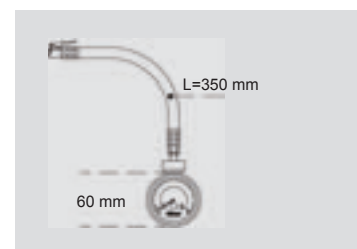

	bar		
1949M	0÷4	280 g	019490400



1949T

Pistola di soffiaggio progressiva telescopica

- Corpo in materiale composito ad alta resistenza, antiurto
- Tubo telescopico in acciaio orientabile: 165 mm ÷ 300 mm
- Dotato di innesto

DATI TECNICI

- Inserto in alluminio filettato: 1/4" GAS
- Pressione di utilizzo: 6÷8 bar
- Pressione massima di utilizzo: 15 bar
- Consumo aria medio: 144 l/min
- Temperatura di utilizzo: -20°C ÷ 70°C

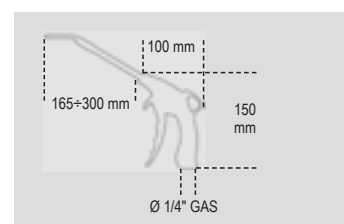

1949T	190 g	019490040



3070

Equilibratrice statica manuale

- Permette l'equilibratura delle ruote in officina e sui campi gara
- Dotata di cuscinetti volventi, livella di posizionamento e piedini regolabili per una massima precisione
- Include coppia di coni per mozzi
- Dimensioni: 480x285x490 mm



3070 9,5 kg 030700000



3070/1

Kit asta centraggio cerchi per 3070



3070/1 200 g 030700001



3070/2

Kit adattatori per ruote monobraccio per 3070



3070/2 300 g 030700002



3070/3

Kit adattatori universali per scooter per 3070

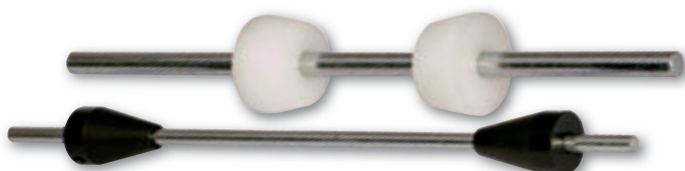

3070/3 1 kg 030700003



3070/4

Kit adattatori per Bmw per 3070



3070/4 300 g 030700004



3075/K10

Set chiave universale a testina intercambiabile e 10 inserti, per serraggio raggi ruote



133x103x30 mm

3075/K10



231 g



030750410



3075A

Chiave a bussola esagonale per dado mozzo ruota

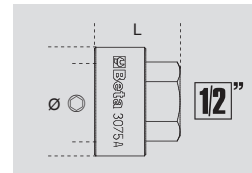

mm	Ø mm	L mm	g	
28	38	30	47	030750028
30	40	30	49	030750030



3075B

Chiave a bussola poligonale per dado mozzo ruota

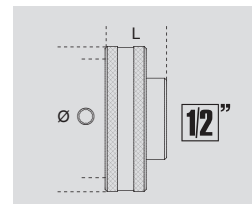

mm	Ø mm	L mm	g	
55	70,7	25	155	030750155



3075/CM

Chiave esagonale maschio multipla per perni ruote

Misure: 12-14-17-19-22-24 mm



3075/CM



34 g



030750212

Cavalletti e sollevatori



3041

Cavalletto anteriore per moto regolabile



3041 2,5 kg 030410001



3040

Cavalletto posteriore per moto regolabile



3040 2,5 kg 030400001



3041A/11

Coppia cursori a rulli per 3041



3041A/11 500 g 030410511



3040A/1

Coppia cursori a V per 3040



3040A/1 xxx 030400501



3041A/15

Coppia cursori a cono per 3041



3041A/15 500 g 030410515



3040A/2

Coppia cursori a L in gomma per 3040



3040A/2 xxx 030400502



3040A/6-8-10

Coppia nottolini in alluminio per 3040A/1



3040A/6	M6x1 mm Aprilia, Yamaha, Triumph	030400506
3040A/8	M8x1.25 mm Suzuki, Honda, Ducati	030400508
3040A/10	M10x1.25 mm Kawasaki	030400510



4 ruote in gomma termoplastica

Porta cursore in acciaio

Verniciatura nera opaca



3042

Cavalletto anteriore per canotto di sterzo moto

- Verniciatura nera opaca
- 4 ruote in gomma termoplastica
- Include kit di 6 perni
- Ø 13 - 14 - 16 - 20 - 26,5

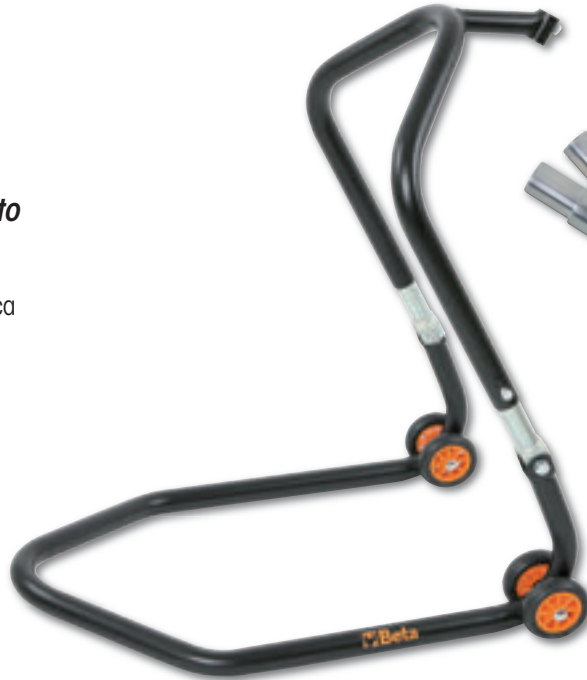

+



3042 4 kg 030420001



3043

Cavalletto per moto con monobraccio SINISTRO

Cavalletto per moto con monobraccio

- Porta cursore in acciaio
- Verniciatura nera opaca
- 4 ruote in gomma termoplastica



3043 3 kg 030430001



3044

Cavalletto per moto con monobraccio DESTRO



3044 3 kg 030440001



3043A

Perno per 3043



		Ø mm	g	
3043A/41	Ducati	21,8	600	030430541
3043A/42	Triumph	27,5	600	030430542
3043A/43	MV - Ducati	42	600	030430543
3043A/44	Ducati 1098	40	600	030430544
3043A/45	Honda	28,6	600	030430545
3043A/46	BMW F800S	30	600	030430546
3043A/47	BMW K,R,S	52,9	600	030430547
3043A/48	Honda CB1000R	28,3	600	030430548



3044A/41

Perno Ducati 848 destro



3044A/41 Ducati 848 29,6 600 g 030440541



3047

Cavalletto cross/enduro a pedale

Dimensioni:

- altezza minima: 290 mm
- altezza massima: 400 mm
- base appoggio: 300x150 mm



3047 7,5 kg 030470001



3048

Cavalletto cross racing in alluminio

Dimensioni:

- altezza: 410 mm
- base appoggio: 300x220 mm

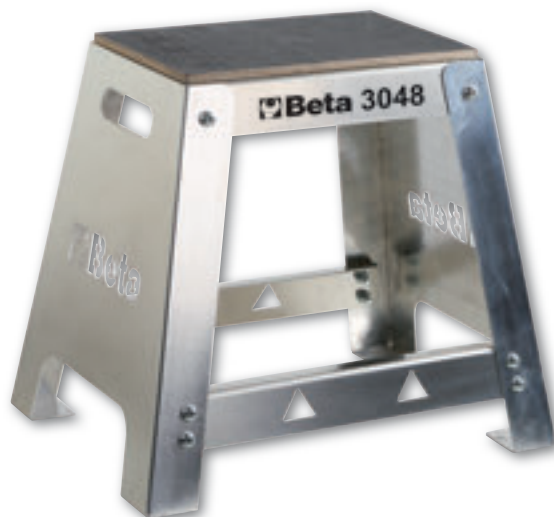

3048 2,5 kg 030480001



3050/C

Cavalletto centrale a vite sotto culla per Custom, Enduro, Cross, Scooter

Include kit di supporti regolabili e tampone in gomma



- Caratteristiche tecniche:
- altezza minima: 90 mm
 - altezza massima: 310 mm
 - capacità: 350 Kg
 - spostamento verticale del carico: 220 mm
 - altezza colonna: 130 mm
 - dimensioni di ingombro: 510x210x170 mm

3050/C 18 kg 030500011



3050/CL

Cavalletto centrale a vite sotto culla largo

Caratteristiche tecniche:

- altezza minima: 90 mm
- altezza massima: 370 mm
- capacità: 350 Kg
- spostamento verticale del carico: 280 mm
- dimensioni di ingombro: 510x300x90 mm

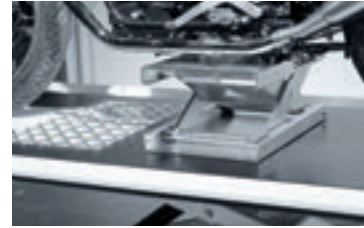
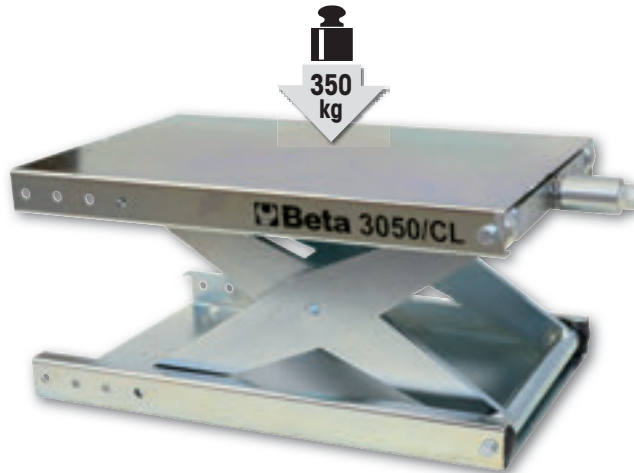

3050/CL 28 kg 030500021



3053

Base sotto-cavalletto per moto con copertura in gomma antiscivolo

- Utilizzabile con tutte le moto e scooter provviste di cavalletto centrale
- Dotato di 4 ruote girevoli in poliuretano, 2 con freno
- Permette di spostare la moto in tutte le direzioni agevolando il parcheggio in garage anche in spazi ristretti
- Disponibile estensione anche per cavalletto laterale (3053/E)
- Dimensioni: 450x460x80 mm



3053 8,5 kg 030530001



3053/E

Estensione 3053 per cavalletto laterale

- Da collegare a base 3053
- Dimensioni: 855x140x80 mm



3053/E 6 kg 030530002





3050/K

Sollevatore moto elettroidraulico da 600 kg

Caratteristiche tecniche:

- sicurezze elettriche, meccaniche e idrauliche
- portata: 600 kg
- centralina elettroidraulica integrata: 1,1 kW - 230V - 7,4A - 50 Hz
- pompa idraulica con portata in salita di 2 lt al minuto
- velocità di discesa controllata da una valvola di flusso da 1 lt/min
- valvola di sicurezza con blocco flusso olio in caso di taglio accidentale al tubo idraulico
- predisposizione pulsantiera con 3 mt. di cavo
- perni montati su boccole autolubrificanti
- guarnizione pistone lubrificata ad ogni ciclo per garantire una maggiore longevità
- sollevatore dotato di 7 posizioni di sicurezza meccanica
- certificato CE e omologato TÜV

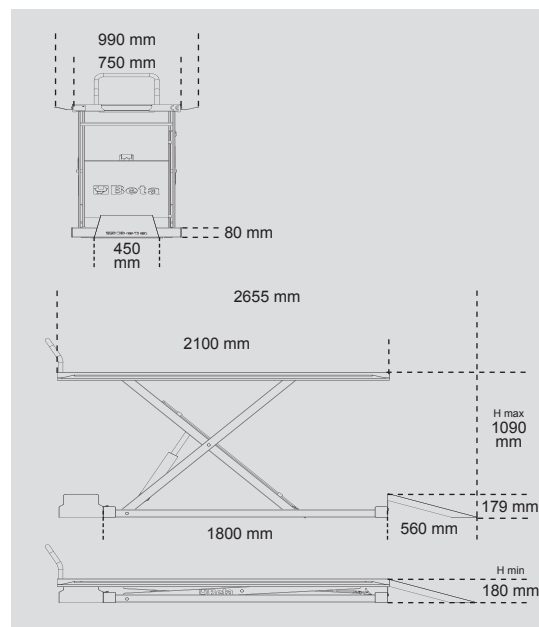

	Icona	Portata	Modello
Orange		180 kg	030500101
Grey		180 kg	030500102
Red		180 kg	030500103



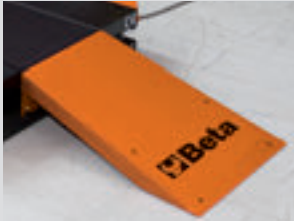

Rampa di salita



Vaschette portautensili laterali



Gate 60x35 cm



Fermaruota



3050/K2

Kit allargamento per sollevatore 3050/K



	3050/K2-O 60 kg	030500121
	3050/K2-G 60 kg	030500122
	3050/K2-R 60 kg	030500123



3050/M

Morsa stringiruota meccanica per sollevatore 3050/K



3050/M	16,5 kg	030500031



3051/LA

Piano in lamiera antiscivolo per sollevatore 3050/K

Dimensioni: 540x340 mm

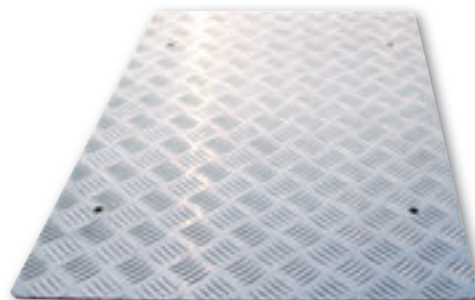

3051/LA	1,6 kg	030510061

Attrezzatura specifica



3055

**Morsa automatica
per furgoni**

Permette il fissaggio della ruota
anteriore della moto



3055 8,7 kg 030550001



3057

**Rampa in alluminio
per carico/scarico moto**

Dimensioni: 1820x300 mm



3057 6,4 kg 030570001





3079/21

Oliatore per cavi

Permette una corretta lubrificazione dei cavi frizione e comando gas aumentando la scorrevolezza delle guaine e la durata dei cavi.



3079/21 40 g 030790021



3091

Estrattori con filetto interno per volano



	M	
3091/10	24x1,5	030910010
3091/20	26x1,0	030910020
3091/30	28x1,0	030910030
3091/40	30x1,0	030910040
3091/45	30x1,5	030910045
3091/50	32x1,5	030910050
3091/60	33x1,5	030910060
3091/70	35x1,0	030910070
3091/75	35x1,5	030910075
3091/80	38x1,5	030910080



3092

Estrattori con filetto esterno per volano



	M	
3092/10	18x1,5	030920010
3092/20	19x1,0	030920020
3092/30	27x1,25	030920030
3092/35	22-26x1,5	030920035
3092/40	25x1,5	030920040
3092/50	26-28x1,0	030920050
3092/60	28x1,5	030920060



3093/E

Attrezzo per bloccaggio volano, campana frizione e pulegge



3093/E 1 kg 030930100



3093/U

Estrattore multiplo per volano

Misure
M10x1.25R
M14x1.5R
M16x1.5R
M18x1.5R
M24x1.0R
M27x1.0L



3093/U 700 g 030930050

Sistemi di ancoraggio



8188F

Sistemi di legatura ad anello LC 200kg con fibbia di serraggio nastro in polipropilene ad alta tenacità (PP)

EN 12195-2



	L m	g	
8188F 1,5	1,5	56	081880215
8188F 2,5	2,5	72	081880225
8188F 5	5	110	081880250



8188C

Sistemi di legatura ad anello LC 800kg con cricchetto tenditore nastro in poliestere ad alta tenacità (PES)

EN 12195-2

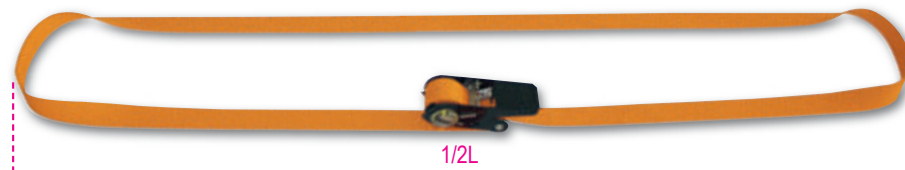

	L m	g	
8188C	5	323 g	081880350



8188CG/25

Sistemi di legatura con 2 ganci ed asole, cricchetto tenditore LC 375kg nastro in poliestere ad alta tenacità (PES)

EN 12195-2

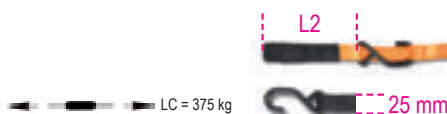
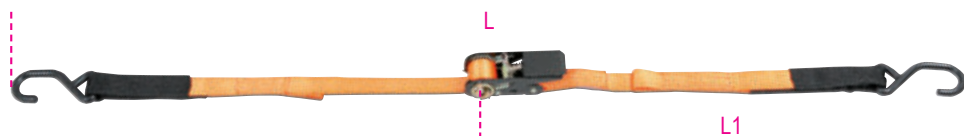

	L m	L1 mm	L2 mm	g	
8188CG/25 3	3	480	170	475	081880430
8188CG/25 5	5	480	170	519	081880450



8188VFG2

Sistemi di legatura con 2 ganci ed asole, fibbia di serraggio LC 250kg nastro in polipropilene ad alta tenacità (PP)

EN 12195-2



	L m	L1 mm	L2 mm	g	
8188VFG2 3	3	450	110	418 g	081881530



8130A

Catene di sicurezza con anello acciaio legato, cementate e bonificate zincate

- Acciaio legato cementato e bonificato per contrastare al meglio le troncatrici manuali.
- Zincatura elettrolitica di alta qualità
- Guaina tessile di protezione: minimizza l'ingombro ed evita i graffi

CERTIFICATI DISPONIBILI

- Rapporto di Prova tipo 2.2 UNI EN10204

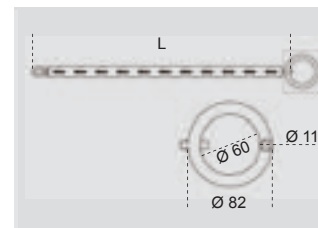

	mm	L mm	kg	
8130A	10	900	1,9	081300209

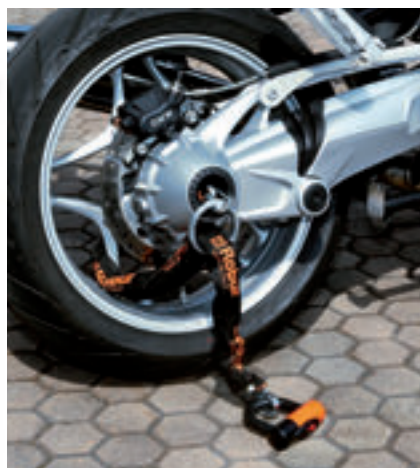

Inclusi nella confezione:

- Astuccio di trasporto
- 3 chiavi
- Cavo segnalatore bloccadisco



8139DL

Lucchetti bloccadisco moto, acciaio temprato, PVC antiurto confezionato in blister

- Cavallo da 14mm in acciaio temprato ricoperto in PVC antigraffio-antiurto
- Resistente al taglio e allo scasso
- Resistente agli agenti atmosferici
- Tappo di protezione per la serratura
- Per catene minimo maglia 10 mm

CERTIFICATI DISPONIBILI

- Rapporto di Prova tipo 2.2 UNI EN10204

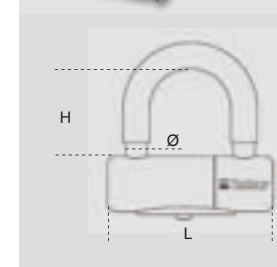

	\emptyset mm	L mm	H mm	g	
8139DL	14	108	56	600	081390214



8130

Catene di sicurezza in acciaio legato cementate e bonificate zincate

- In acciaio legato con maglie a sezione semiquadra, cementate e bonificate per contrastare al meglio le troncatrici manuali.
- Zincatura elettrolitica di alta qualità.
- Guaina tessile di protezione: minimizza l'ingombro ed evita i graffi.

CERTIFICATI DISPONIBILI

- Rapporto di Prova tipo 2.2 UNI EN10204

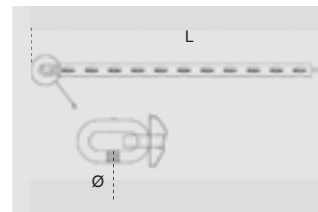

	Ø mm	L mm	kg	
8130 6X800	6	800	0,58	081300068
8130 8X1000	8	1000	1,47	081300081
8130 8X1200	8	1200	1,67	081300082
8130 10X1500	10	1500	3,15	081300105



8139Z

Lucchetti per catene di sicurezza, corpo in lega di zinco confezionato in blister

- Cavallo da 10 mm in acciaio temprato, con doppio bloccaggio.
- Resistente al taglio e allo scasso.
- Resistente agli agenti atmosferici.
- Chiavi di sicurezza mappate.
- Per catena maglia 6 e 8 mm

CERTIFICATI DISPONIBILI

- Rapporto di Prova tipo 2.2 UNI EN10204

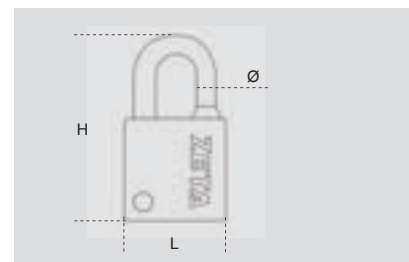
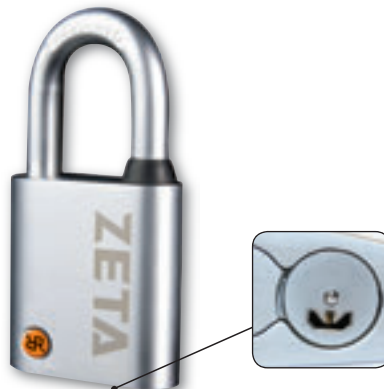

	Ø mm	L mm	H mm	kg	
8139Z	10	55	98	400 g	081390009



8139ZCH

N.3 chiavi di ricambio neutre per lucchetti 8139Z

- Duplicabili con punzonatrice



8139ZCH 081390909



Beta **R S C 5 5**

Configura on-line la tua officina
www.beta-tools.it/RSC55



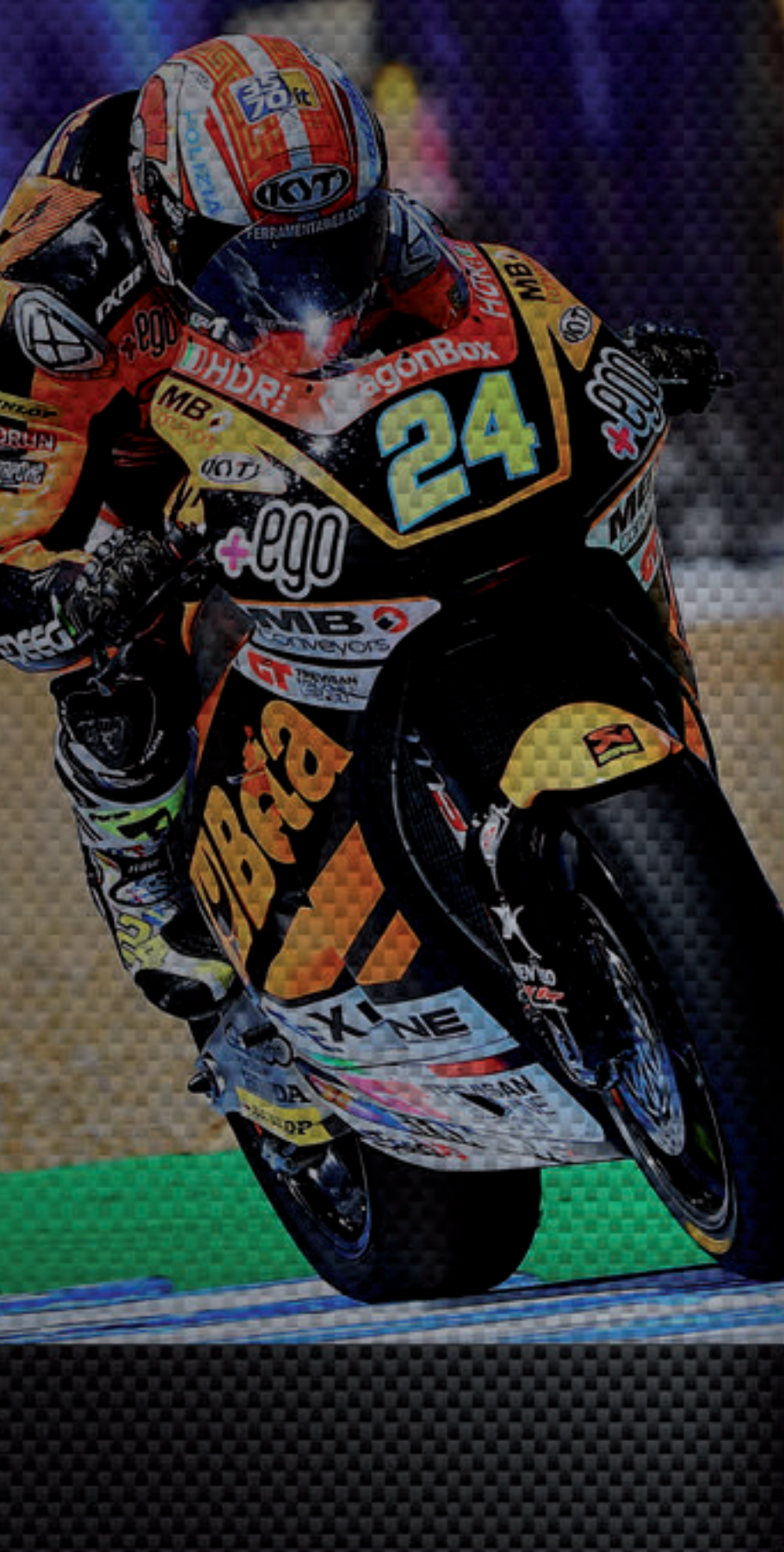

Beta

Beta Utensili S.p.A.
Via A. Volta 18
20845 Sovico (MB)
Tel.039.20771
www.beta-tools.it

SPEEDUP
Racing Spirit

Simone Corsi
Moto2 World Championship

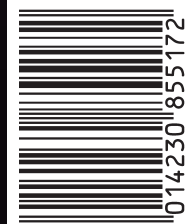

099804294

8 014230 855172